



joli

lasting
memories.



joli

lasting
memories.



People are designed to be together.
Life is crafted to be lived.
Fully. Unrestricted. Unbounded.

So, please.
Come to the table.
Eat. Play. Talk. Think. Work.
Create memories and make them last.
We are Joli.

Our tables are anchors of life.
Surviving seasons and generations.
Bringing people together.

Lasting memories.



09 About us

- 11 Lasting memories
- 13 Belgian customized design

15 Our collections

- 16 Central
- 22 Chagall
- 32 Curve
- 52 Fizz
- 68 Gaugin
- 72 Layers
- 80 Marguerite
- 100 Morisot
- 106 Propeller
- 112 Rafael
- 122 Wire

149 Our cabinets

- 152 Cube 55
- 160 Cube 70
- 168 Cube 83
- 174 Cube 193

179 Our accessories

Side tables:

- 180 Collins
- 186 Flower

Table accessories:

- 194 Bite, Heatt, Turnable Disc

209 Choice for quality

- 210 Surviving seasons and generations
- 212 Xeramica®
- 214 Fenix®
- 216 Matilux®
- 218 Fabrics
- 223 Maintenance



about us

Lasting memories 11

Belgian customized design 13



lasting memories

Since its foundation in 1996, quality has been at the core for Joli. This is reflected in the stainless steel and aluminium tables with ceramic tabletops. But also in the other high-quality furniture, such as chairs, loungers, cabinets and accessories. Thanks to their durability, the furniture is more than just an object. It becomes the place where you create lifelong memories.

Joli manufactures furniture that meets current material and stability standards, all aligning with the newest design trends.

Furthermore, we also offer bespoke furniture on request. Thanks to a wide range of finishes in a variety of styles, a great eye for detail and an ear to the latest developments in market trends, Joli manages to offer designs that are both timelessly modern and trendy.



belgian customized design

Joli is a Belgian quality brand for customized tables, chairs, accessories, loungers and cabinets. One by one handmade.

This also ensures that Joli can offer custom-made craftsmanship. With this offer, we occupy a unique position worldwide. Curious what we can do for you? Feel free to reach out via info@joli.be.

Our products are 100% Belgian in terms of quality and design. We work exclusively with domestic designers. We are constantly looking for new techniques and improvements to create lasting memories.

Get ready to be inspired!

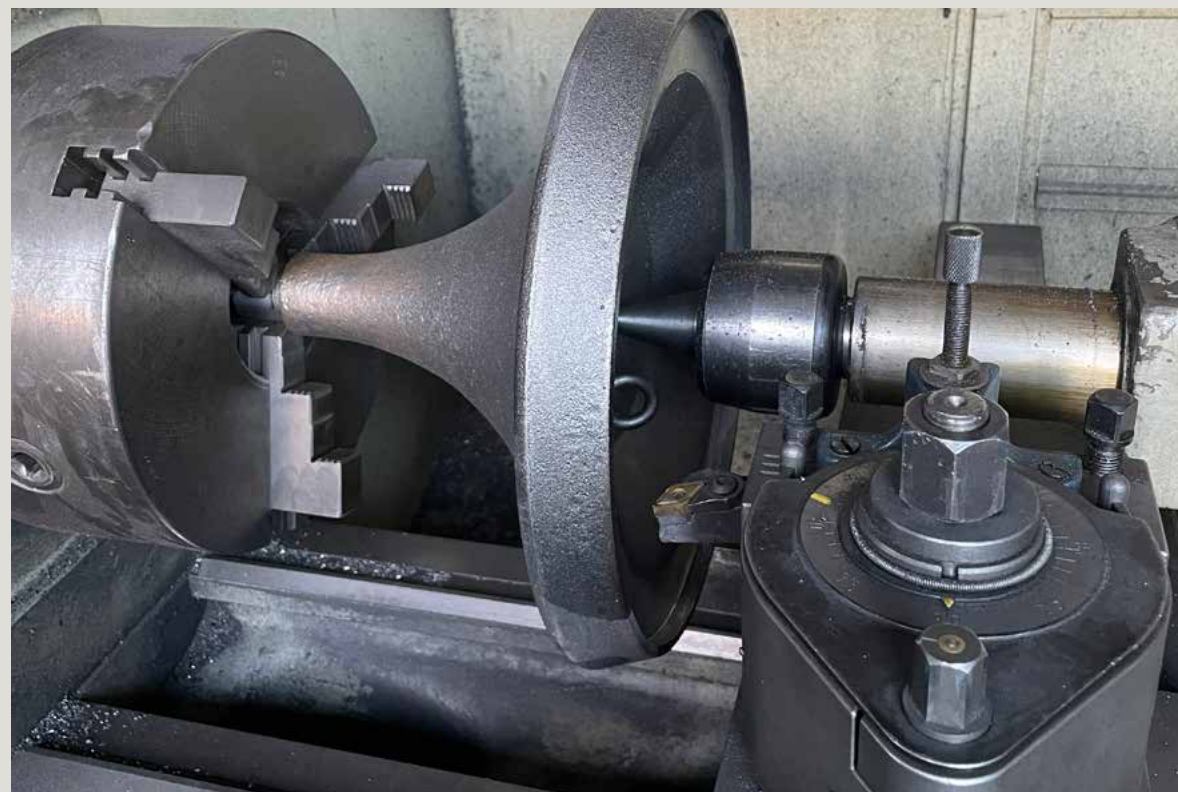

www.joli.be

[@joli_belgium](https://www.instagram.com/joli_belgium)



our collections

Central	16
Chagall	22
Curve	32
Fizz	52
Gauguin	68
Layers	72
Marguerite	80
Morisot	100
Propeller	106
Rafael	112
Wire	122

central

Meet our Central table. We present it to you proudly, with a round, elyps and square table top. It's ready to become the centerpiece of your home. The central table foot provides great freedom of movement under the table. Lots of table space, carefully mounted on a compact, yet steady, trestle. Finished with an as practical and stylish ceramic tabletop.

The Central table includes the sharknose, a rejuvenating edge, as a standard finish for the ceramic top (only with Xeramica® 13 mm).

[click here](#)





central elyps (170 cm) with table top Xeramica® charisma grey and sharknose finish

We keep refining
our know-how. As a
trendsetter, we keep a
close eye on our
potential customers.



central round (140 cm) with table top Xeramica® charisma grey and sharknose finish | wire dining chair

central

indoor & outdoor

Designed by Mathias De Ferm

dimensions



				diameter of the base
elyps	160	90	74.5	37
	160	70	74.5	37

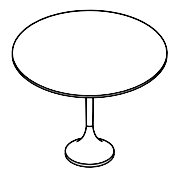

			diameter of the base
round	140	74.5	37
	120	74.5	37
	100	74.5	37
	80	74.5	37

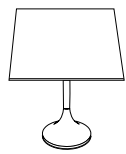

			diameter of the base
square	100	74.5	37
	80	74.5	37

frame

metalised cast iron + stainless steel

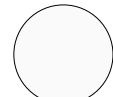

white



lino



taupe



bronze



anthracite



black

finish

calacatta: normal border. all 13 mm ceramics: sharknose.



normal border
only for 6 + 6 mm

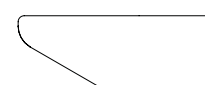

sharknose
only for 13 mm

table tops

6 + 6 mm

Calacatta

13 mm

Absolute white
Black iron
Caravaggio
Charisma grey

Emperador
Lava brown
Marble azuro
Marble marone

Soft oak
Travertino grey

detail: sharknose



chagall

The ultimate in femininity: Chagall's 'egg cup' curves are organic and graceful. The shaped foam seat can be upholstered in vegan leather or a fabric with a pleasant feel. This beautiful designed armchair is available with either a fixed foot (x-base or sled base) or spinning foot. Despite its strikingly light structure this is a strong, long-lasting chair.

[click here](#)





chagall spinning in easy care flax | wire majestic (5 m) with table top Xeramica® ceramic calacatta



chagall spinning in velvet beige





chagall spinning in corallo blue | fizz big round (150 cm) with table top Xeramica® marble azuro



chagall sled base in easy care truffle | propeller dining table (250 cm) with table top Xeramica® soft oak | cube 55 in Matilux® bronze (code: 2L/space/3L)

chagall

Designed by John Ghekiere

dimensions



sled base



spinning

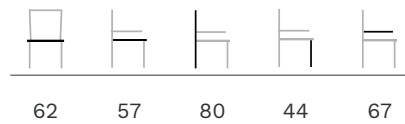

x-base



frame

lacquered metal

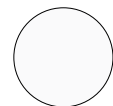

white



lino



taupe



bronze



anthracite



black

fabrics

easy care

tabacco
truffle
stone
flax

corallo

charcoal
beige
cherry
blue

vegan leather

black
anthracite
dark brown
cognac
taupe
lino
white

velvet

black
beige
blue
orange
green

smooth

ash
sooty
canvas
tagine





curve
collection

curve

Organic lines, that's what this collection is all about. These lines cause both the tables and the chairs to be a visual delight. The table frame is characterised by a triangular extrusion profile which, in combination with light, leads to an elegant play of shadow lines. The Curve chairs and tables can be put together in such a way that they complement any decor. The chairs are perfect for long days of sitting, because the slight curve and the flexible upper part allow you to sit up straight without looking too stiff.

[click here](#)



curve elyps (250 cm) with lino frame and table top Xeramica® travertino grey | fizz armchairs in rope solemio lino



curve faux elyps (300 cm) with table top Xeramica® caravaggio | curve chair in smooth tagine

curve faux elyps

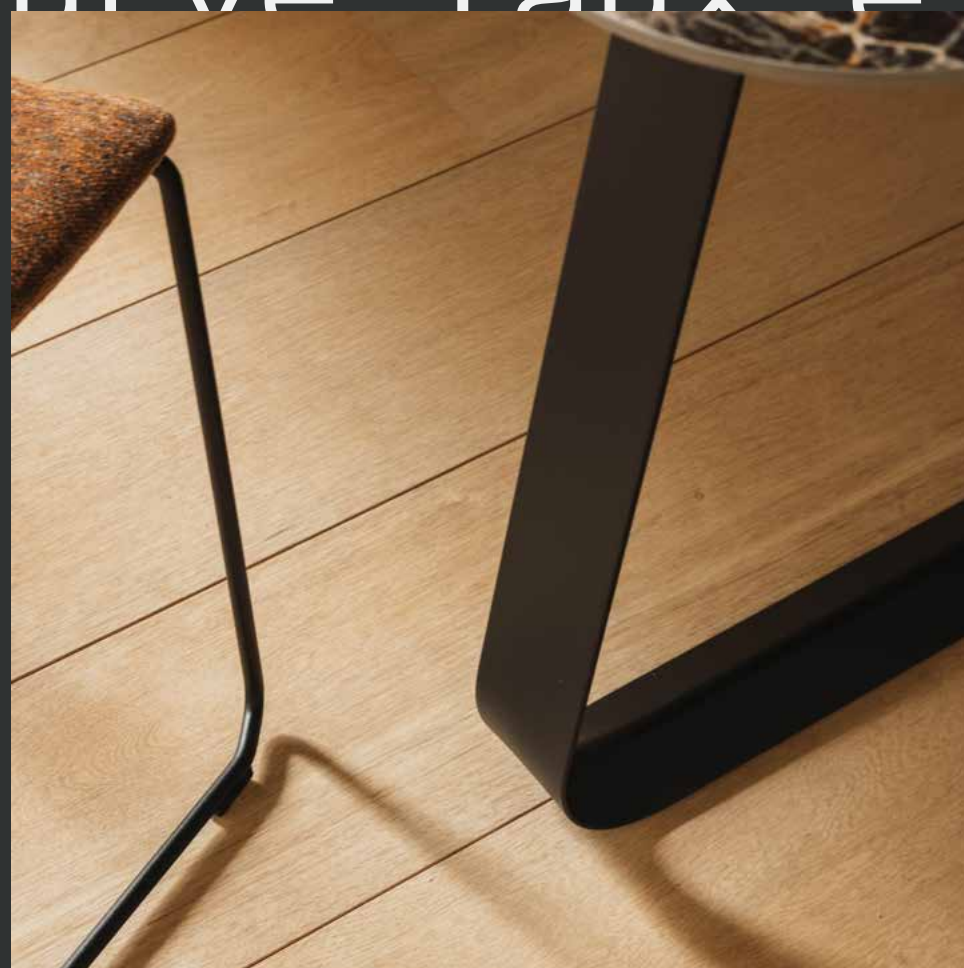

meet the designer

john ghekiere

John Ghekiere, also known as Mister Joli, established Joli in 1996. As founder of the furniture brand, he is keen to see the company grow and develop. R&D is therefore his main focus. His keen interest in innovation, superior materials and a sharp eye for functional design are an intrinsic part of his personality. The creation of new products are his greatest passion.



curve e1yps



curve e1yps (300 cm) with bronze frame and table top Xeramica® calacatta | curve chairs in easy care flax | heatt dia 45 in Xeramica® absolute white



curve e1yps (250 cm) with lino frame and table top Xeramica® travertino grey | fizz armchairs in rope solemio lino



curve round (150 cm) with table top Xeramica® charisma grey and sharknose finish | curve chairs in easy care fabric stone | heatt dia 60 in Xeramica® charisma grey

curve round



curve round (150 cm) with table top Xeramica® charisma grey and sharknose finish | fizz armchairs in rope solemio charcoal



curve coffee tables round (50 and 60 cm) in bronze with table top Xeramica® caravaggio | rafael bar stools sled base

curve coffee table



curve coffee table elyps (160 cm) with table top Xeramica® charisma grey | wire 3-seat with cushion in smooth sooty

curve extendable



curve rectangular extendable (215 - 315 cm) with table top Xeramica® black iron | chagall sled base in corallo cherry



curve faux elyps extendable with table top Xeramica® marble marone



curve faux elyps extendable (220 - 320 cm) with table top Xeramica® marble marone | chagall sled-base in corallo beige

Smooth lines determine
the refined personality
of this collection.

curve faux elyps extendable (220 - 320 cm) with table top Xeramica® black iron | rafael chairs sled-base in corallo cherry



curve faux elyps extendable (220 - 320 cm) with table top Xeramica® marble marone | curve armchair in smooth sooty

curve

indoor & outdoor

Designed by John Ghekiere

dimensions

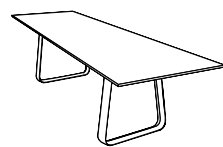

rectangular	300	100	75	230	68.5
	250	100	75	180	68.5
	220	100	75	150	68.5
	200	100	75	138	68.5
	180	90	75	110	68.5

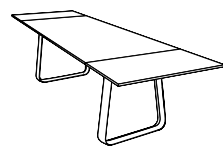

rectangular extendable XL / XXL *	215 - 315	100	75	180	65.8
	160 - 240	100	75	136	65.8

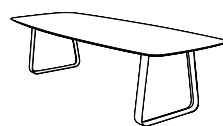

faux elyps	300	110	75	230	68.5
	250	110	75	180	68.5
	220	110	75	150	68.5
	200	110	75	138	68.5
	180	100	75	110	68.5

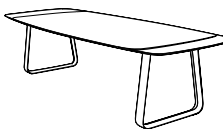

faux elyps extendable XL / XXL *	220 - 320	110	75	180	65.8
	165 - 245	110	75	136	65.8

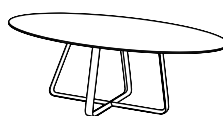

elyps	300	128	75	140	68.5
	250	128	75	140	68.5
	210	128	75	140	68.5



round	150	75	73
	120	75	73
	100	75	73

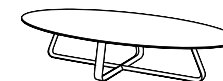

coffee table	180	90	30
elyps	160	70	30
	120	60	30

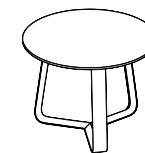

coffee table round	120	30
	100	30
	80	30
	60	40
	50	50

frame

lacquered metal

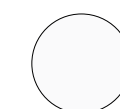

white



lino



taupe



bronze



anthracite



black

finish



normal border

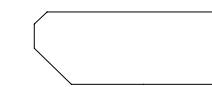

faux elyps

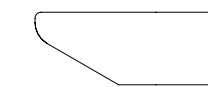

sharknose
only for 13 mm

table tops

6 + 6 mm

Calacatta*

13 mm

Absolute white
Black iron
Caravaggio
Charisma grey

Emperador
Lava brown
Marble azuro
Marble marone

Soft oak
Travertino grey

* not for extendable tables

curve

Designed by John Ghekiere

indoor & outdoor

dimensions

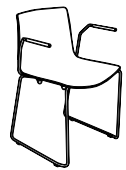

armchair



chair

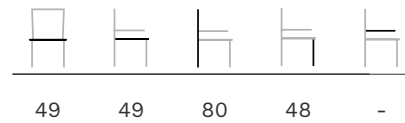

frame

indoor: lacquered metal

outdoor: lacquered stainless steel

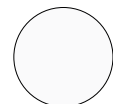

white



lino



taupe



bronze



anthracite



black

fabrics

indoor

easy care

tabacco
truffle
stone
flax

velvet

black
beige
blue
orange
green

corallo

charcoal
beige
cherry
blue

vegan leather

black
anthracite
dark brown
cognac
taupe
lino
white

indoor & outdoor

smooth

ash
sooty
canvas
tagine

nautic linen

carbon
pepper
earth
sand
salt
sahara
bamboo
ocean



curve elyps (250 cm) with table top Xeramica® caravaggio | curve chairs in vegan leather cognac

A black metal outdoor dining set consisting of a round table and four chairs, set on a grassy lawn under a large tree. A small bowl of food sits on the table. The scene is captured in a soft, natural light, suggesting a peaceful outdoor setting.

fizz
collection

fizz

The starting point of this collection is organically shaped aluminium. The slender, feminine lines and curves give these tables and chairs a visual lightness.

The seat pattern was inspired by traditional rattan. Replacing this with high-end Italian rope produces an extremely attractive and recognisable modern look. Not only is the rope very comfortable to sit on, it is also totally wheaterproof and dries extremely quick.

[click here](#)



fizz big round (150 cm) with table top Xeramica® charisma grey | fizz armchair in rope solemio charcoal



fizz armchair in lino and rope solemio lino | curve elyps (250 cm) in lino with table top Xeramica® travertino grey

The challenge is to
make a design that is
beautiful, ergonomical
and ecological at the
same time.

- Mathias De Ferm



embrace outdoor living



fizz bistro round tripod (dia 70 cm, height 75 cm) with table top Xeramica® black iron | fizz armchairs in rope solemio charcoal



fizz big round (dia 150 cm) with table top Xeramica® marble azuro | fizz armchairs in rope solemio charcoal



fizz bistro round tripod (dia 70 cm, height 110 cm) with table top Xeramica® marble marone



fizz bistro square tripod (70 cm, height: 75 cm) with table top Xeramica® emperador | fizz armchairs rope solemio charcoal with cushion nautic linen carbon



fizz bistro round tripod (dia 70 cm, heights: 66, 75, 90 and 110 cm) in lino with table tops Xeramica® lava brown and travertino grey | wire bar stool lino | wire dining chair lino



fizz big round (dia 150 cm) with table top Xeramica® black iron | marguerite armchairs with shell in leather black | wire low chair black with cushion in leather cognac | collins low black | cube 70 in Matilux® black



fizz big round (dia 150 cm) white with table top Xeramica® absolute white | rafael sled base white in easy care flax | heatt dia 60 in Xeramica® absolute white

Designed by Mathias De Ferm

dimensions



big dining round			
	150	75	68.5
	120	75	68.5



big dining square			
	150	75	68.5
	120	75	68.5



bistro round tripod table with click system		
	70	66 / 75 / 90 / 110
	80	66 / 75 / 90 / 110

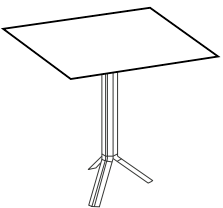

bistro square tripod table with click system		
	70	66 / 75 / 90 / 110

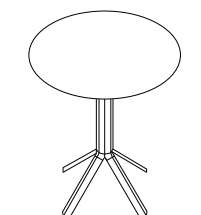

bistro round 4-legs table without click system		
	80	66 / 75 / 90 / 110
	100	66 / 75 / 90 / 110

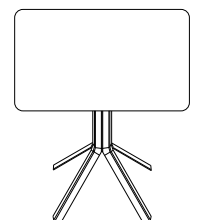

bistro square 4-legs table without click system		
	80	66 / 75 / 90 / 110

frame

lacquered aluminium



white



lino



taupe



bronze



anthracite



black

finish



normal border

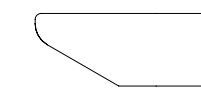

sharknose only for 13 mm

table tops

6 + 6 mm

Calacatta

13 mm

Absolute white
Black iron
Caravaggio
Charisma grey

Emperador
Lava brown
Marble azuro
Marble marone

Soft oak
Travertino grey

fizz

indoor & outdoor

Designed by Mathias De Ferm

dimensions



armchair
cushion

50	61	79	46	65
49	45	-	-	-

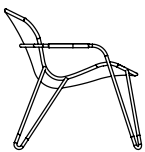

low chair
cushion

59	76	69	39	54
62	45	-	-	-

frame

lacquered metal



lino



black

rope solemio

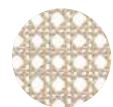

lino

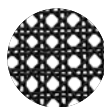

charcoal

fabrics cushions

smooth

ash
sooty
canvas
tagine

nautic linen

carbon
pepper
earth
sand
salt
sahara
bamboo
ocean



fizz low chair in lino and rope solemio lino

gaugin

In a short time, working from home has become more and more normal for many people. Therefore, a comfortable chair that seats you well is important. Comfortable but not too bulky, that's the Gaugin. Combined with the Vespa wheels, you easily move along your desk without scratching the floor. This chair is also a great option for a dining table.

[click here](#)



gaugin armchair in corallo charcoal with Vespa wheels in black | wire elyps (250 cm) with table top Xeramica® calacatta

gaugin

Designed by John Ghekiera

dimensions



chair

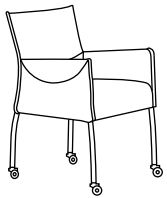
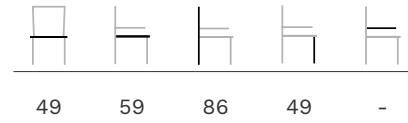

armchair



frame and cover

metal frame, nosag springs

easy care tabacco
truffle
stone
flax

corallo charcoal
beige
cherry
blue

leather black
anthracite
nutella
cognac
pearl
beige
taupe
grey
white

velvet black
beige
blue
orange
green

smooth ash
sooty
canvas
tagine

vespa wheels

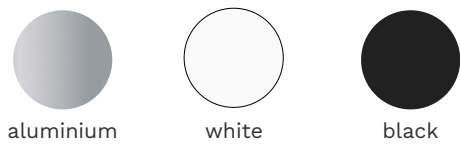

aluminium

white

black



layers

With a table top that appears to float, this table looks very light and spacious. This in combination with one of the eleven ceramic tabletops makes Layers an excellent and elegant table for indoor and outdoor use.

[click here](#)



layers rectangular (300 cm) with table top Xeramica® soft oak | rafael x-base chair in vegan leather black

layers dining table (300 cm) with table top Xeramica® soft oak | fizz chairs in rope solemio charcoal





layers dining table (300 cm) with table top Xeramica® soft oak | rafael sled base in easy care flax | collins low black















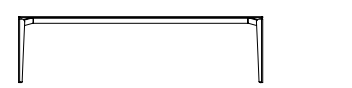

layers dining table (300 cm) with table top Xeramica® black iron | fizz armchairs in rope solemio charcoal | bite large in oak | heatt 140 in Xeramica® black iron

layers

indoor & outdoor

Designed by Sylvain Willenz

dimensions

					
 dining table	300	100	75	289	67.5
	250	100	75	239	67.5
	220	100	75	209	67.5
	200	100	75	189	67.5
	180	90	75	169	67.5
 wall table	200	40	75	-	67.5
	160	40	75	-	67.5
 coffee table					
	150	100	29		
	130	70	29		
 lamp table					
	55	55	43		

frame

dining table: lacquered stainless steel | wall, coffee & lamp table: lacquered metal

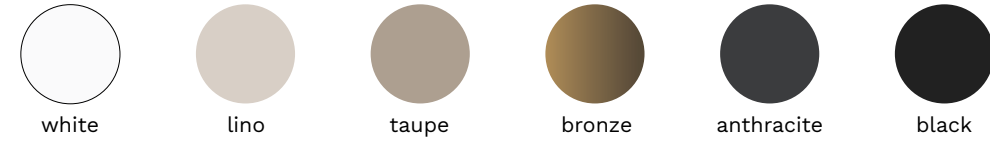

finish



normal border

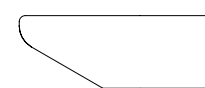

sharknose
only for 13 mm

table tops

6 + 6 mm

Calacatta

13 mm

Absolute white
Black iron
Caravaggio
Charisma grey

Emperador
Lava brown
Marble azuro
Marble marone

Soft oak
Travertino grey



layers dining table (300 cm) with table top Xeramica® soft oak

marguerite
collection



marguerite

A true masterpiece, Marguerite only reveals its secrets to the careful observer. The unassuming design of the table and the character of its conical legs make it an easy fit for any environment, whether indoors or outdoors. At the same time, its presence adds a subtle but priceless elegance to any occasion.

Next to the tables and chairs you can find your perfect outdoors lounge in this collection. Within seconds you turn the lounge into a sofa. Alongside this practical and comfy sofa/lounge you can place the newest addition in this collection: round coffee tables.

[click here](#)



red dot award



GERMAN
DESIGN
AWARD
SPECIAL
2017



DESIGN
AWARD
2016



marguerite lounge with cushions in nautic linen carbon | collins low black



marguerite sofa & lounge in white with cushions in nautic linen salt | marguerite coffee tables round (120, 60 and 50 cm) in white with table top Xeramica® absolute white

meet the designer

mathias de ferm

Mathias De Ferm is a product and furniture designer from Antwerp, Belgium. Collaborating with renowned international brands, his work includes furniture, products, lighting and micro-architecture.

His work is characterized by a strong belief in the social relevance of design. A dining table, for instance, is not limited to its practical qualities. It forms the social centerpiece of a home: a place where people gather to eat, drink and talk with each other. This idea led to a serene yet warmhearted aesthetic and the frequent use of durable materials.





marguerite round (día 150 cm) with table top Xeramica® charisma grey | wire dining chairs with cushions smooth ash



marguerite round (día 150 cm) with table top Xeramica® black iron | rafael x-base in vegan leather black



marguerite rectangular extendable (200 - 260 cm) with table top Xeramica® black iron | marguerite armchair with cushion in nautic linen carbon



marguerite rectangular extendable (200 - 260 cm) with table top Xeramica® calacatta | marguerite chair with cushion in smooth canvas



marguerite rectangular extendable with table top Xeramica® calacatta (see video via button)

[click here](#)



marguerite elyps (300 cm) with table top Xeramica® charisma grey | wire dining chair with cushion in smooth sooty



marguerite elyps (300 cm) with table top Xeramica® charisma grey | wire dining chair with cushion in smooth sooty

marguerite

indoor & outdoor

Designed by Mathias De Ferm

dimensions

rectangular	300	100	75	290	67.5
	250	100	75	240	67.5
	220	100	75	210	67.5
	200	100	75	190	67.5
	180	90	75	170	67.5
	140	90	75	130	67.5
rectangular extendable XL / XXL	200 - 260	100	75	190	67.5
	160 - 220	100	75	150	67.5
square	150	150	75	140	67.5
	130	130	75	120	67.5
	100	100	75	90	67.5
square bistro	70	70	75	60	67.5
square lamp	55	55	46.5	45	43
elyps					
	300	128	74.5	165.7	73.3
	250	128	74.5	127.7	73.3
	210	128	74.5	127.7	73.3
round					
	150	75	73.5		
	120	75	73.5		
	100	75	73.5		



coffee table rectangular	130	70	32	120	29
coffee table square	100	100	32	90	29

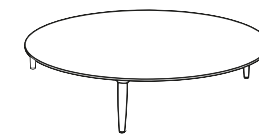

coffee table round	120	24 / 31 / 37
	100	24 / 31 / 37
	80	24 / 31 / 37
	60	24 / 31 / 37
	50	24 / 31 / 37

frame

fully alu lacquered

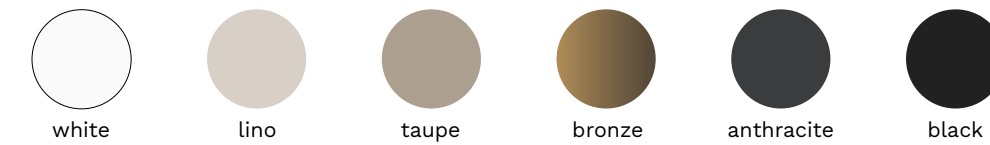

finish

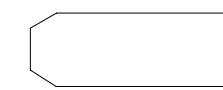

normal border

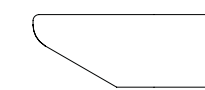

sharknose
only for 13 mm

table tops

6 + 6 mm	Calacatta	13 mm	Absolute white Black iron Caravaggio Charisma grey	Emperador Lava brown Marble azuro Marble marone	Soft oak Travertino grey
----------	-----------	-------	---	--	-----------------------------

marguerite

indoor & outdoor

Designed by Mathias De Ferm

dimensions



armchair
cushion
shell



57	54	79	49	66
45	44	-	-	-
44	49	-	-	-



chair
cushion
shell



45	54	79	49	-
45	44	-	-	-
44	49	-	-	-

frame

lacquered aluminium

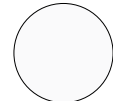

white



lino



taupe



bronze



anthracite



black

fabrics cushions or shell

indoor

easy care

tabacco
truffle
stone
flax

velvet

black
beige
blue
orange
green

corallo

charcoal
beige
cherry
blue

leather

black
anthracite
nutella
cognac
pearl
beige
taupe
grey
white

indoor & outdoor

smooth

ash
sooty
canvas
tagine

nautic linen

carbon
pepper
earth
sand
salt
sahara
bamboo
ocean



marguerite armchairs in lino | curve elypt table (300 cm) with table top Xeramica® travertino grey

marguerite

indoor & outdoor

Designed by Mathias De Ferm

dimensions

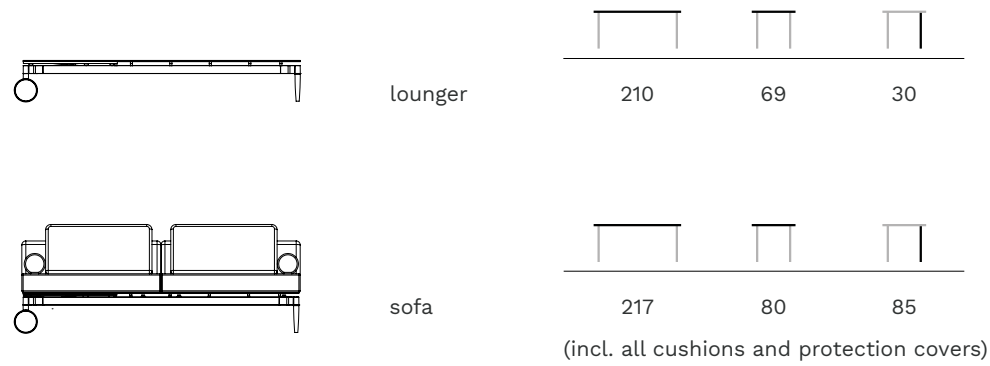

frame

lacquered aluminium

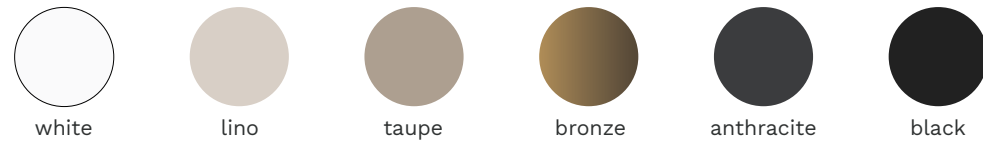

fabrics

smooth

ash
sooty
canvas
tagine

nautic linen

carbon
pepper
earth
sand
salt
sahara
bamboo
ocean

transform your
lounge in a sofa



morisot

Our newest chair: the Morisot. Perfect for long hours of creating memories around your table. The open armrest and the egg-shaped shell give Morisot excellent seating comfort. They combine soft shapes with a firm backrest and handy armrests.

Keep an eye on this chair, because there are still some fine versions to come.

[click here](#)





morisot sled base in velvet beige

A decent table needs
well chosen chairs. This
is how we create places
where memories are made.

morisot x-base in easy care flax

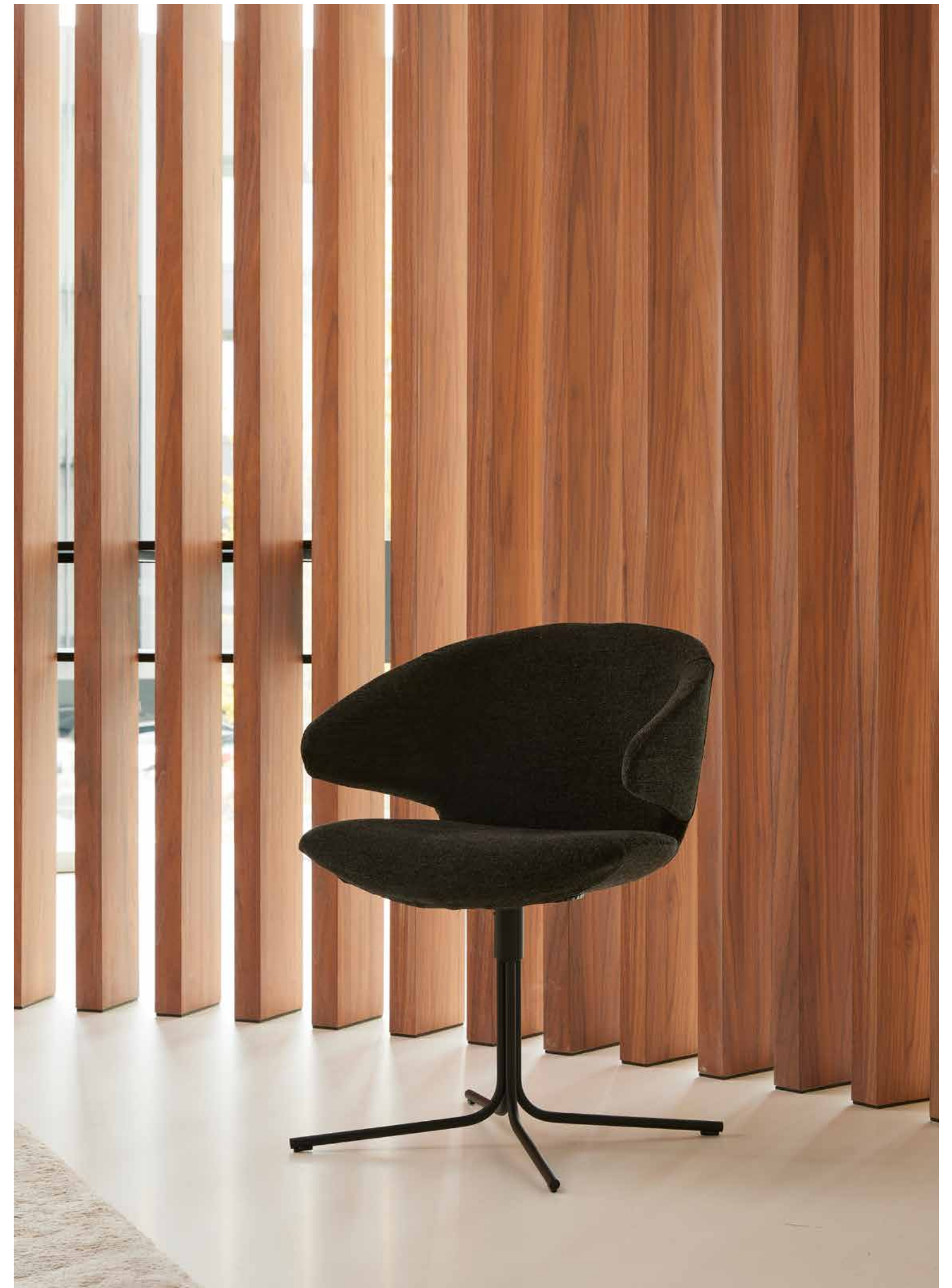
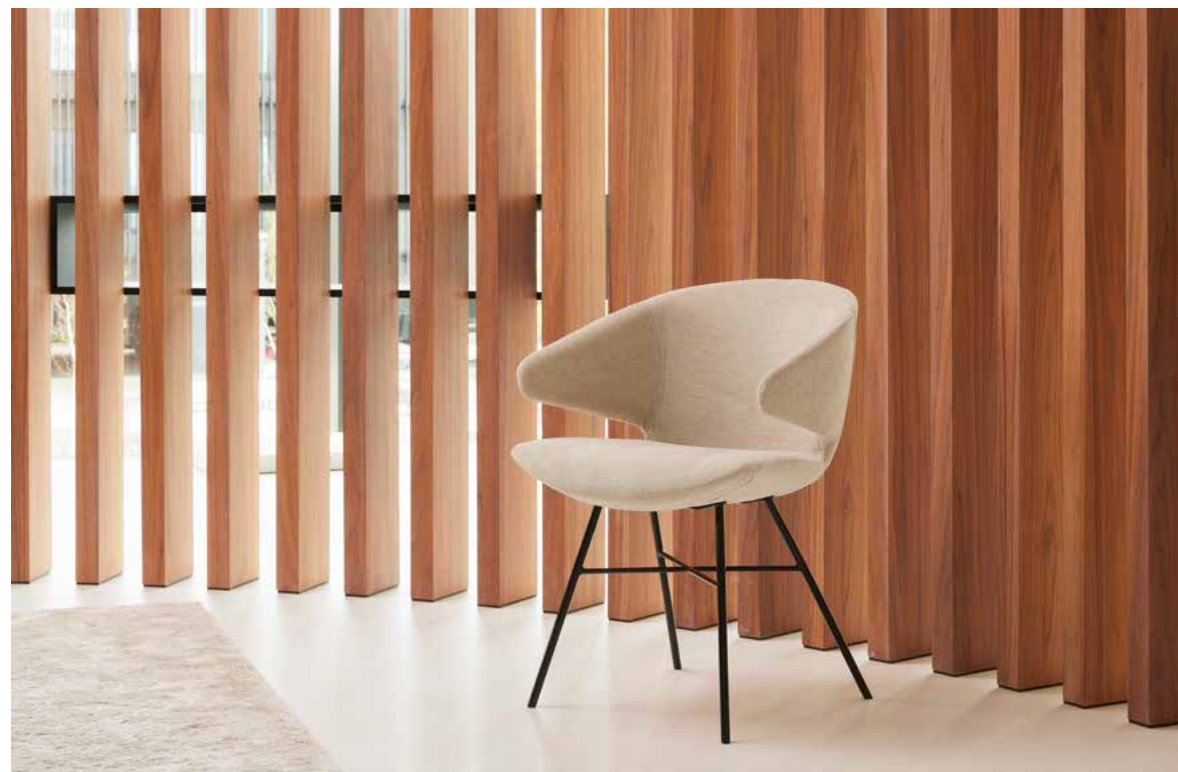

morisot spider-base in smooth sooty

morisot

Designed by John Ghekiere

dimensions



sled base



spider base

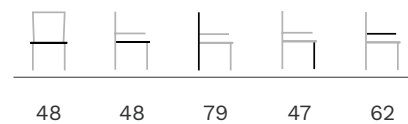

x-base



frame

lacquered metal

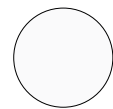

white



lino



taupe



bronze



anthracite



black

fabrics

easy care

tabacco
truffle
stone
flax

corallo

charcoal
beige
cherry
blue

vegan leather

black
anthracite
dark brown
cognac
taupe
lino
white

leather

black
cognac
white

velvet

black
beige
blue
orange
green

smooth

ash
sooty
canvas
tagine



propeller

The sleek, streamlined Propeller dining table exudes peace and strength. The base, crafted in stainless steel and inspired by aircraft propellers, ensures stability.

[click here](#)



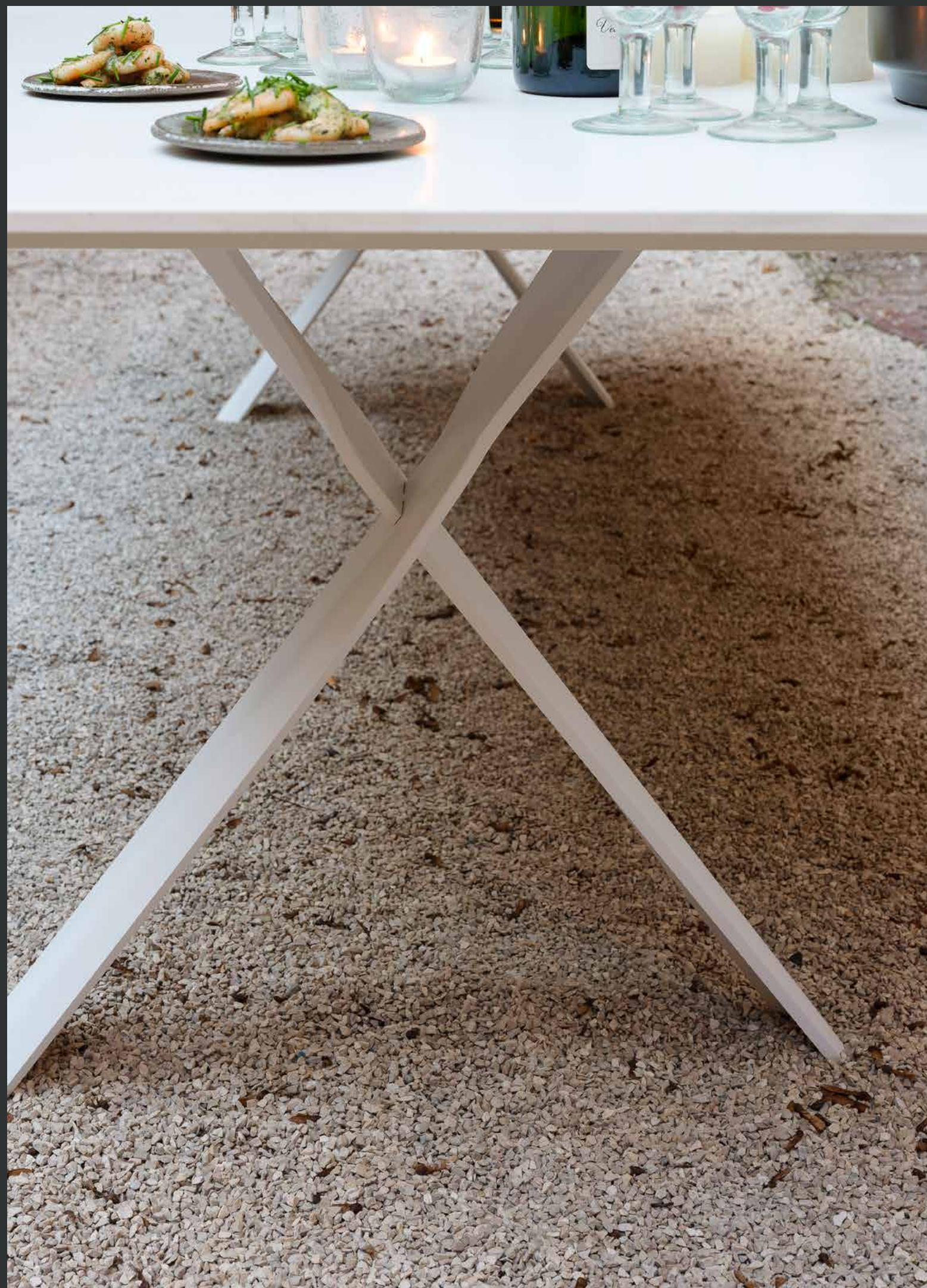

propeller rectangular (300 cm) in white with table top Xeramica® absolute white



propeller dining table (250 cm) with table top Xeramica® soft oak | chagall sled base in easy care truffle | cube 55 in Matilux® bronze (code: 2L/space/3D)

propeller

indoor & outdoor

Designed by John Ghekiere

dimensions

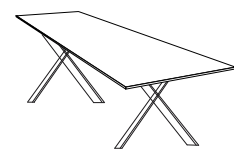

rectangular	300	100	75	194	68.5
	250	100	75	144	68.5
	220	100	75	114	68.5
	200	100	75	94	68.5
	180	90	75	74	68.5



faux elyps	300	110	75	194	68.5
	250	110	75	144	68.5
	220	110	75	114	68.5
	200	110	75	94	68.5
	180	100	75	74	68.5

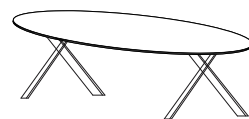

elyps	300	128	75	134	67.5
	250	128	75	84	67.5
	210	128	75	84	67.5

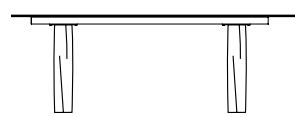

wall table	200	40	75	135	68.5
rectangular	160	40	75	95	68.5



coffee table	150	100	38	-	31.5
rectangular	130	70	38	-	31.5
	100	100	38	-	31.5

frame

dining tables: lacquered stainless steel, wall tables: lacquered aluminium

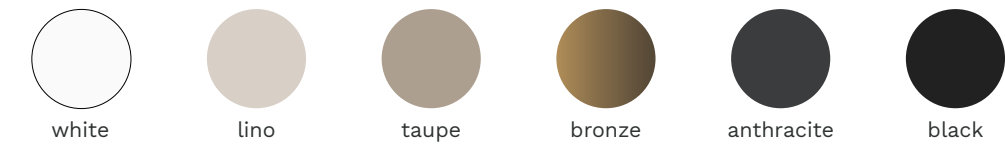

finish



normal border



faux elyps



sharknose
only for 13 mm

table tops

6 + 6 mm	Calacatta	13 mm	Absolute white Black iron Caravaggio Charisma grey	Emperador Lava brown Marble azuro Marble marone	Soft oak Travertino grey
----------	-----------	-------	---	--	-----------------------------

rafael

Modern, stately and surprisingly comfortable: the Rafael chair is a must for anyone looking for the ultimate combination of sober refinement and warm conviviality. The minimalist design gives your living room a sophisticated aura. The seating gyrates on the base for optimal comfort.

[click here](#)



rafael x-base in vegan leather black | marguerite round (dia 150 cm) with table top Xeramica® black iron



rafael x-base in vegan leather black | marguerite round (día 150 cm) with table top Xeramica® black iron



rafael sled base in white in easy care flax | fizz big round (dia 150 cm) in white with table top Xeramica® absolute white | heatt dia 60 in Xeramica® absolute white



rafael x-base in easy care truffle | wire faux elyps (250 cm) with table top Xeramica® marble marone

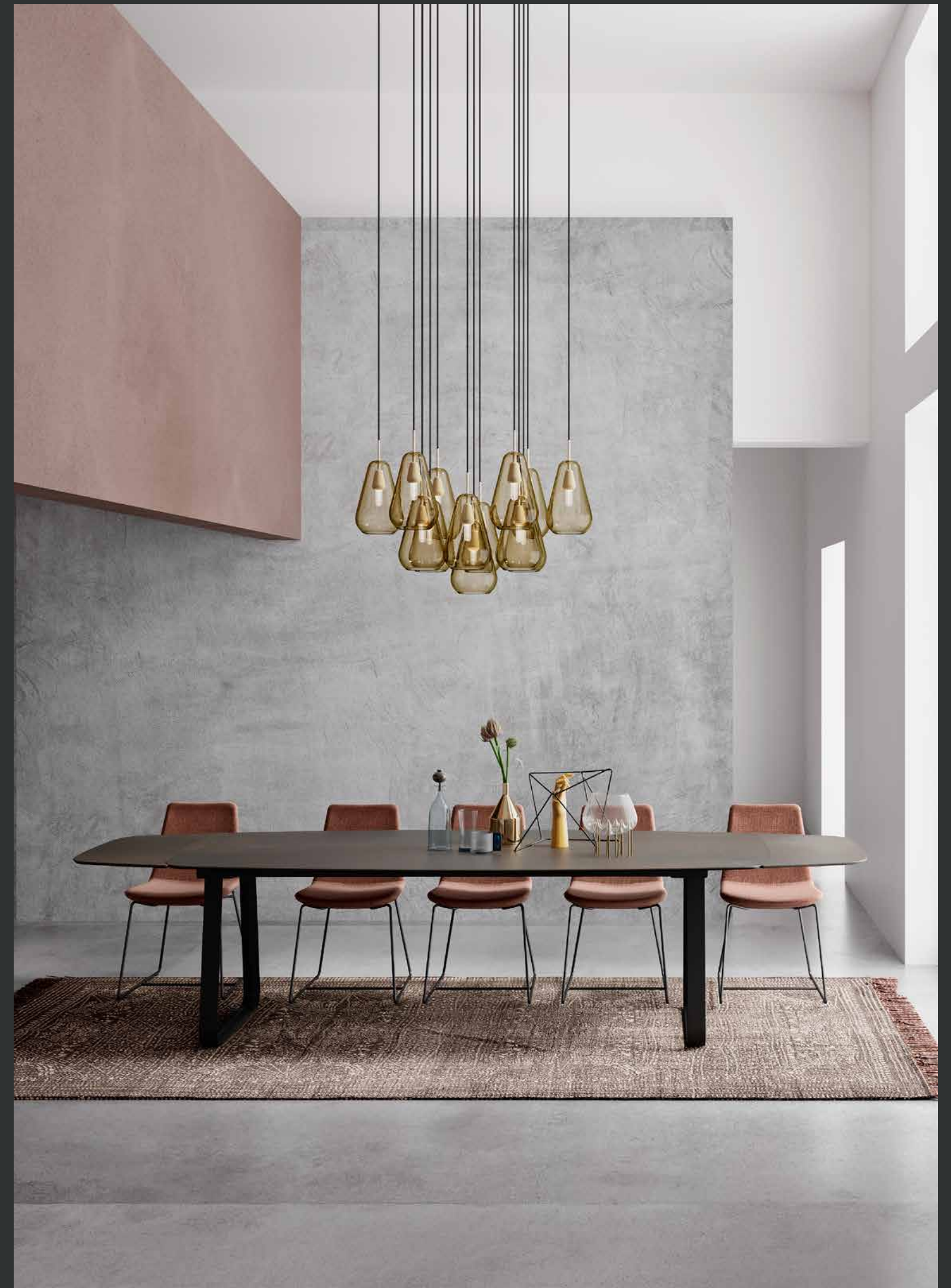

rafael sled base in corallo cherry | curve faux elyps extendable (220 - 320 cm) with table top Xeramica® black iron



rafael bar stool spinning in vegan leather black



rafael bar stool sled base in vegan leather black

rafael

Designed by John Ghekiera

dimensions



office



sled-base



x-base



armchair



bar stool

low
high

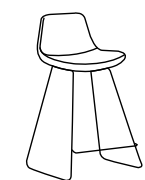
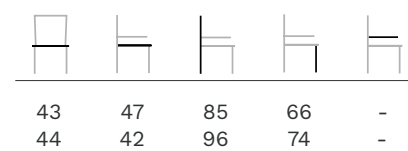

bar stool
sled base

low
high

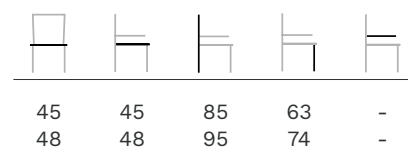

frame

lacquered metal

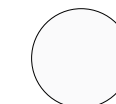

white



lino



taupe



bronze



anthracite



black

fabrics

easy care

tabacco
truffle
stone
flax

corallo

charcoal
beige
cherry
blue

vegan leather

black
anthracite
dark brown
cognac
taupe
lino
white

velvet

black
beige
blue
orange
green

smooth

ash
sooty
canvas
tagine



wire
collection

wire

The idea behind the Wire collection, a design by Mathias De Ferm, is ingeniously simple. The tables and chairs are fashioned from fine, stainless steel wire: a single collection with one highly recognisable design line.

These are suitable for both indoors and outdoors, are lightweight and solid, and are available in versatile finishes with a range of tabletops. A striking detail is that the legs are angled outwards from a central point, giving the entire piece an even lighter look.

[click here](#)



wire majestic (6 metres) with white frame and table top Xeramica® calacatta | wire armchairs in white with cushion smooth canvas

Lasting memories



wire coffee table elyps (120 cm) with table top Xeramica® black iron | wire 3-seat

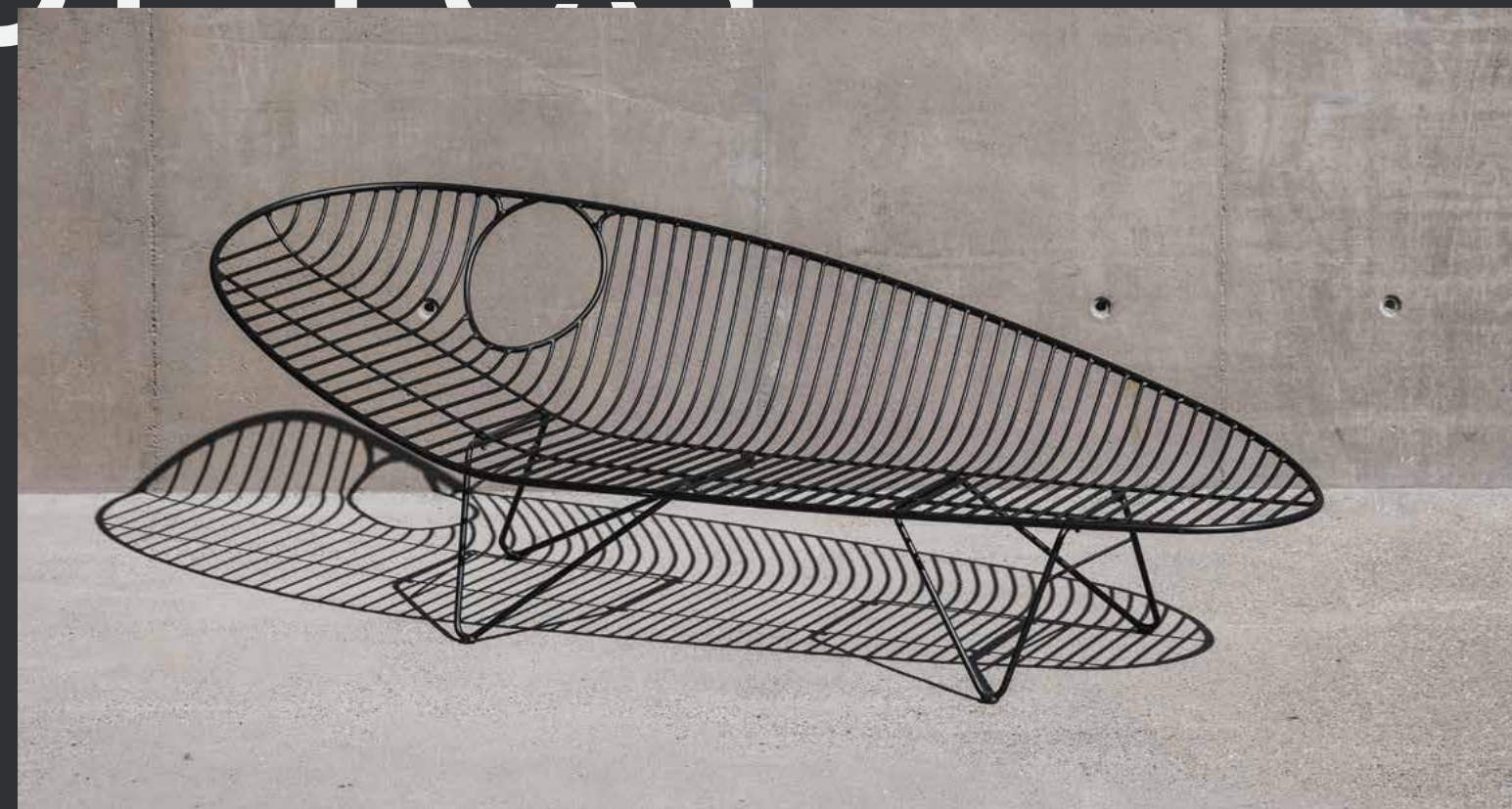

wire lounge



Our chairs, cabinets,
and ofcourse tables
are durable products,
designed to last and to
be used intensively.



wire majestic (5 metres) with table top Xeramica® calacatta | chagall spinning chairs in easy care flax

wire majestic



wire majestic (5 metres) with table top Xeramica® calacatta | chagall spinning chairs in easy care flax

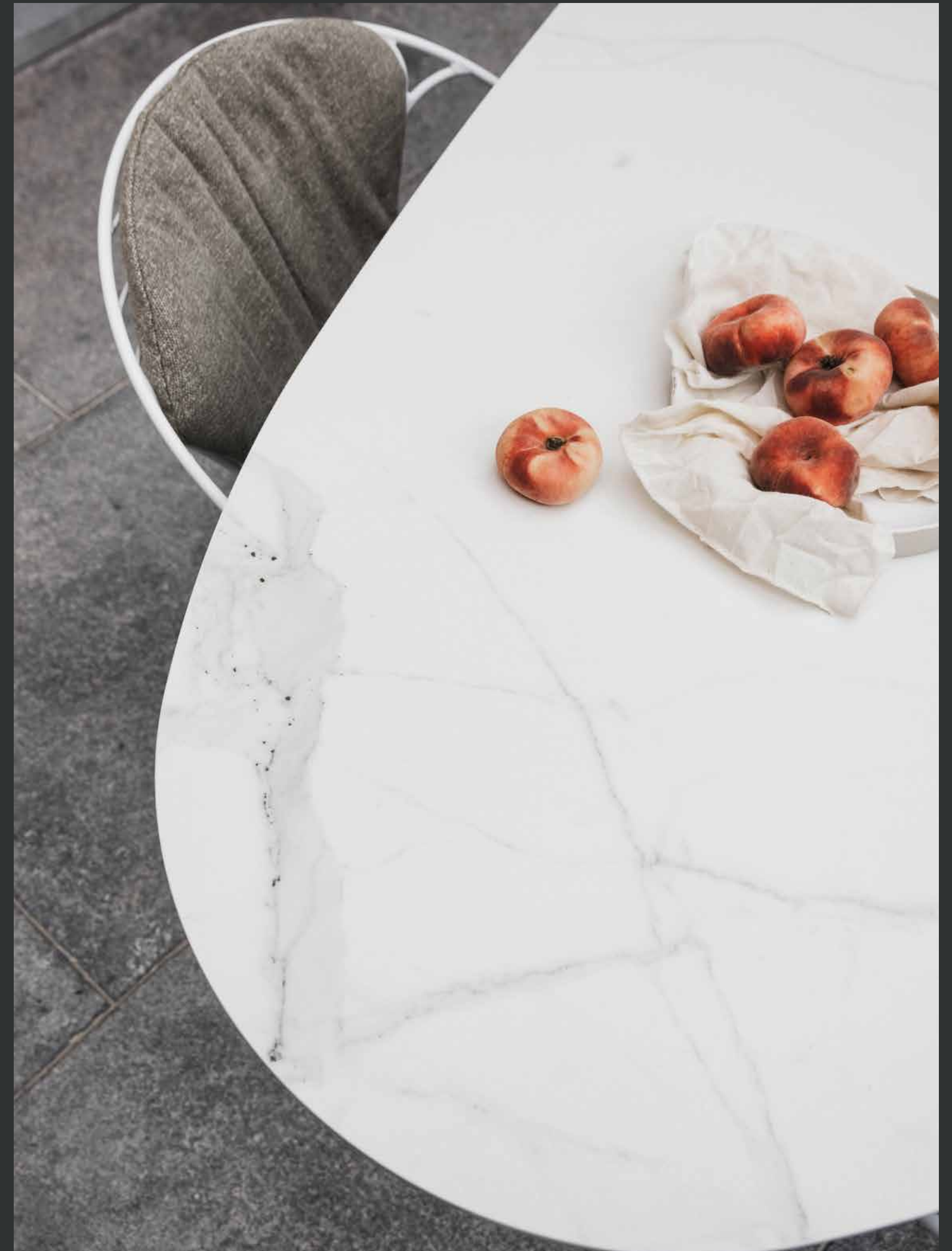

wire majestic (6 metres) with white frame and table top Xeramica® calacatta | wire armchairs in white with cushion smooth canvas



wire majestic (5 metres) with table top Xeramica® marble marone | wire armchairs with cushions smooth canvas



wire majestic (6 metres) with table top Xeramica® marble marone | wire armchairs with cushions in smooth canvas



wire faux elyps (250 cm) with table top Xeramica® marble marone | wire armchairs with cushions in smooth ash



wire low chair in lino with cushion in nautic linen earth



wire elyps (300 cm) with table top Xeramica® calacatta | curve armchairs in vegan leather black | wire barstools with cushion in smooth tagine



wire dining chair in white with cushion smooth canvas



wire dining chairs with cushion in smooth ash | marguerite round (150 cm) with table top Xeramica® charisma grey



wire barstools with cushion in nautic linen earth



wire round low dining (120 cm) with table top Xeramica® calacatta | wire low chairs



wire rectangular (300 cm) with table top Xeramica® black iron | wire dining chairs











wire low chairs with cushions in smooth tagine | collins low and high black

wire





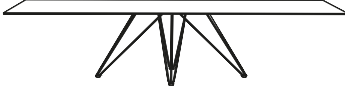
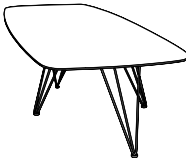
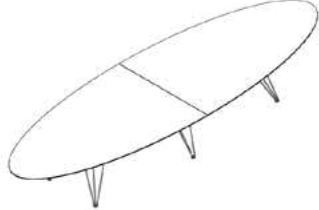
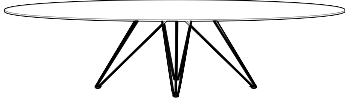

indoor & outdoor

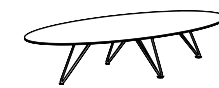
Designed by Mathias De Ferm

dimensions

							
rectangular		300	100	75 / 66	197	74 / 102	69 / 60
		250	100	75 / 66	147	74 / 102	69 / 60
		220	100	75 / 66	108	74 / 102	69 / 60
		200	100	75 / 66	108	74 / 102	69 / 60
		180	90	75 / 66	108	74 / 102	69 / 60
square		150	150	75 / 66	99	99	69 / 60
		130	130	75 / 66	77	77	69 / 60
faux elyps		300	110	75 / 66	197	74 / 102	69 / 60
		250	110	75 / 66	147	74 / 102	69 / 60
		220	110	75 / 66	108	74 / 102	69 / 60
		200	110	75 / 66	108	74 / 102	69 / 60
		180	100	75 / 66	108	74 / 102	69 / 60
majestic		600	150	75	411	101	69
		500	150	75	311	101	69
		400	150	75	211	101	69
elyps		300	128	75 / 66	147	74	69 / 60
		250	128	75 / 66	147	74	69 / 60
		210	128	75 / 66	147	74	69 / 60
round		dia 150	75 / 66	dia 77	dia 77	69 / 60	
		dia 150	75 / 66	dia 77	dia 77	69 / 60	



							
coffee table elyps		160	70	29	118	48	23
		120	60	29	89	48	23
coffee table rectangular		100	100	29	86	86	23
		150	100	29	135	85	23
		130	70	29	108	48	23

frame

lacquered stainless steel

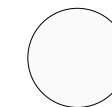

white



lino



taupe



bronze



anthracite



black

finish

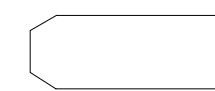

normal border



faux elyps

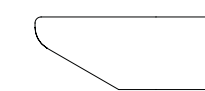

sharknose
only for 13 mm

table tops

6 + 6 mm

Calacatta

13 mm

Absolute white
Black iron
Caravaggio
Charisma grey

Emperador
Lava brown
Marble azuro
Marble marone

Soft oak
Travertino grey

wire

indoor & outdoor

Designed by Mathias De Ferm

dimensions

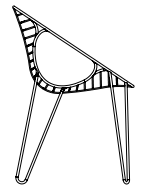

armchair
cushion

61	55	78	46	63
53	47	-	-	-

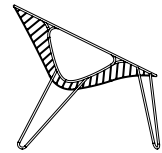

low chair
cushion

76	74	74	45	53
63	55	-	-	-

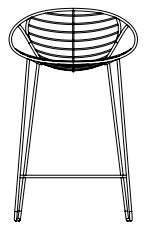

bar stools
cushion

51	53	86	67	74
44	42	-	-	-

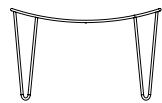

tabouret

66	49	-	40	-



2-seat

135	67.5	74.5	37	-

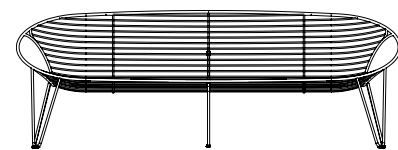

3-seat

210	68.5	74.5	36.5	-

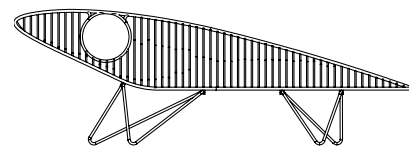

lounger

201	72.7	68.5	38.5	-

frame

lacquered stainless steel



white



lino



taupe



bronze



anthracite



black

fabrics cushions

indoor

easy care

tabacco
truffle
stone
flax

corallo

charcoal
beige
cherry
blue

velvet

black
beige
blue
orange
green

leather

black
anthracite
nutella
cognac
pearl
beige
taupe
grey
white

indoor & outdoor

smooth

ash
sooty
canvas
tagine

nautic linen

carbon
pepper
earth
sand
salt
sahara
bamboo
ocean



our cabinets

Color options	151
Cube 55	152
Cube 70	160
Cube 83	168
Cube 193	174



color options

inside the cube

Melamine

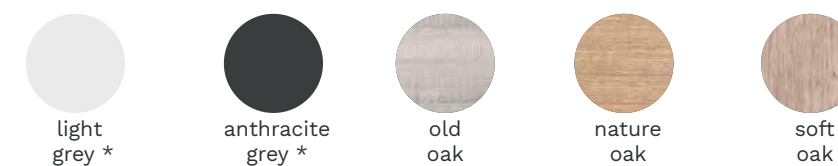

* standard colour

hinges and tip-on



black

doors, top and sides

Matilux®

4 mm



Fenix®

4 mm



[click here](#)

option - ceramic top

Xeramica®

Not possible for Cube 193

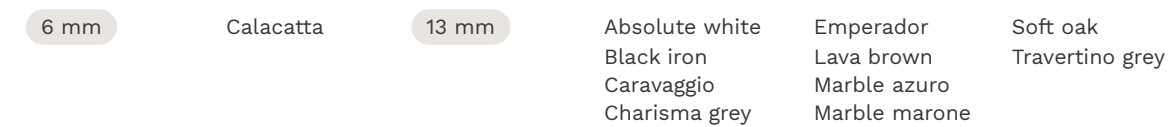

cube 55

The smallest in its collection, namely 55 cm high. You start with one 55 x 55 cm block and then combine it with other blocks from the Cube 55 collection to easily create your perfect cupboard. Standing or hanging, it does not matter!

[click here](#)

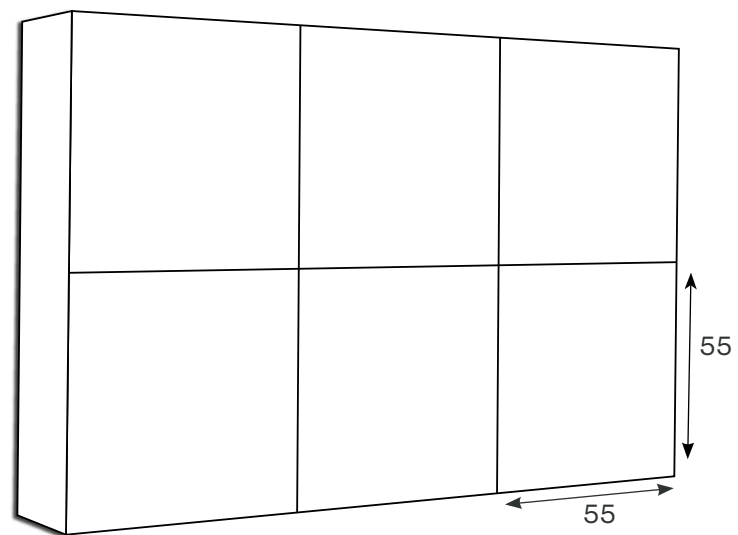

cube 55 triple in Matilux® white with vitrine door and led spot

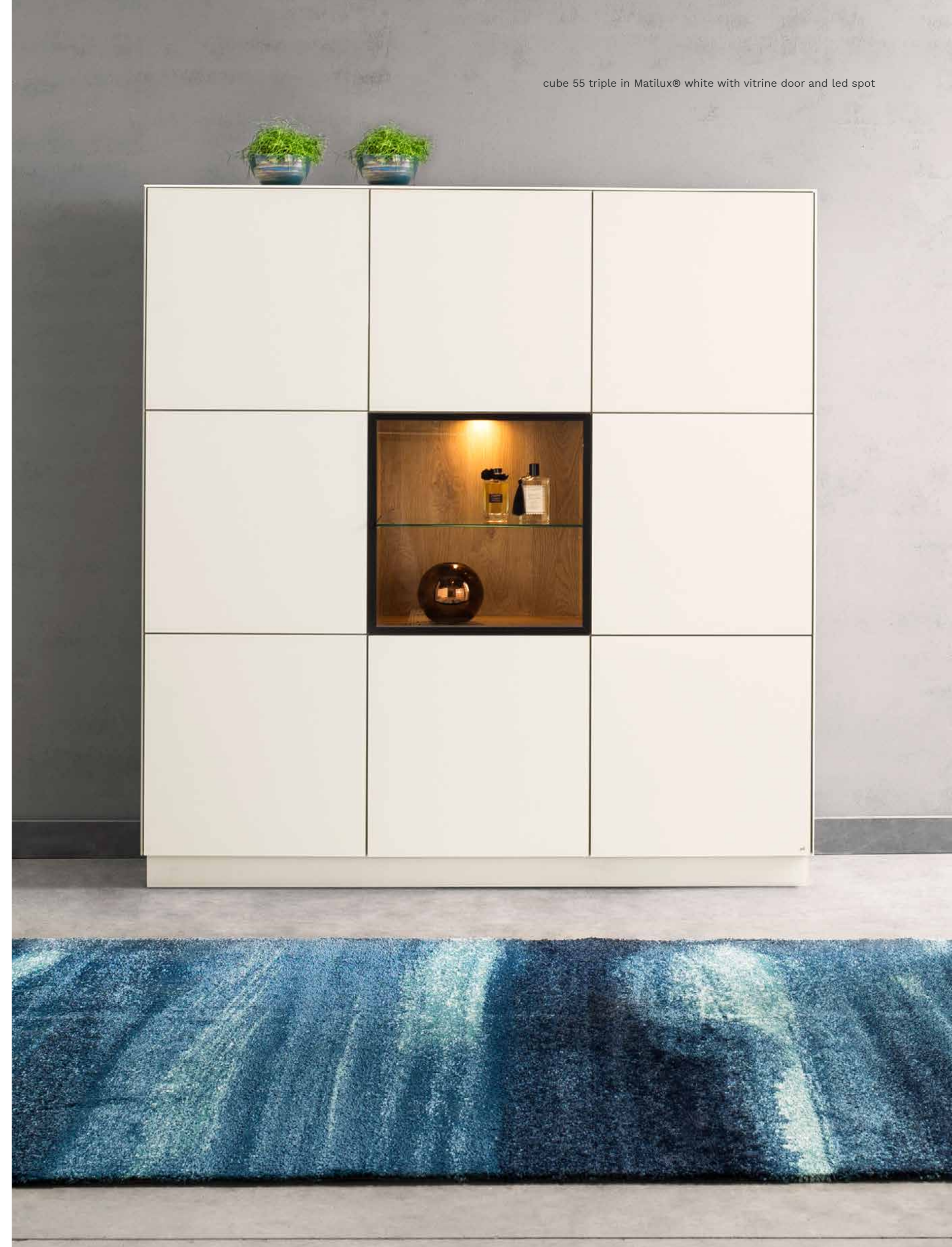



cube 55 in Matilux® bronze and space in Matilux® black



cube 55 in Matilux® anthracite, a Xeramica® top in black iron and Wire legs

cube 55

Designed by Chris Vankeirsbilck

- hinge
 - push point
 - cabinet
 - - - fixed partition
 - > rotation direction
- max. load 20 kg / door

elements

	width	height	depth	code
	55	55	40	1D
	80	55	40	LDD
	97.5	55	40	LL
	55	55	40	3L
	30	55	40	SPACE <i>only possible if placed between 2 other elements</i>
	30	55	40	1SD

options

1. legs under cabinet: lacquered aluminium or frame Wire (white, black, anthracite, lino or taupe).
2. cable opening for TV cabinet
3. door 'vitrine' 55 x 55 cm clear glass/black frame
4. LED spot (incl. remote control)
5. base in Matilux®; standard for double and triple (height 8 cm) (wooden frame finished with Matilux® glass adjustable in height)
6. ceramic top

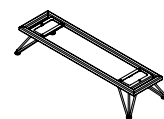





cube 55 double in Matilux® bronze with vitrine door and led spot and with 3 drawers



cube 55 examples

Designed by Chris Vankeirsbilck

-  hinge
-  push point
-  cabinet
-  fixed partition
-  rotation direction

max. load 20 kg / door

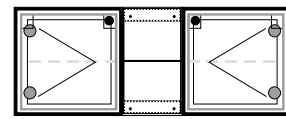

door space door

width	height	depth	code
140	55	40	D-Space-D

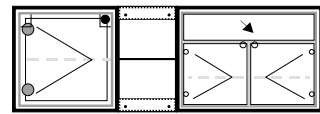

door space drawer & 2 doors

width	height	depth	code
165	55	40	D-Space-LDD

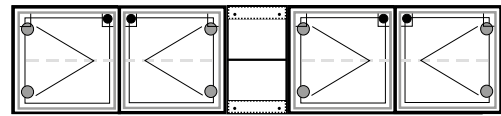

1 door 1 door space 1 door 1 door

width	height	depth	code
250	55	40	2D-Space-2D

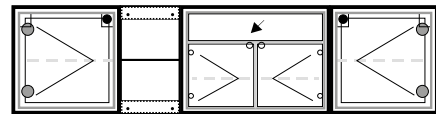

door space drawer & 2 doors door

width	height	depth	code
220	55	40	D-Space-LDD-D

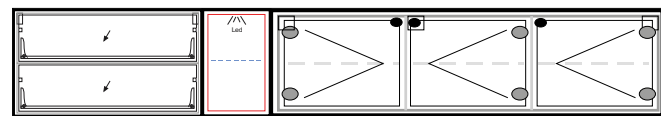

2 drawers + lamp space 3 doors

width	height	depth	code
292,5	55	40	D-Space + lamp-LDD-D

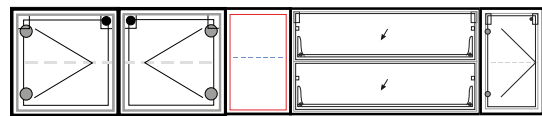

1 door 1 door space 2 drawers 1 small door

width	height	depth	code
292,5	55	40	2D-Space-LL-1SD

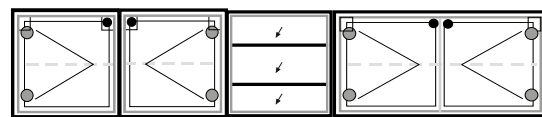

1 door 1 door 3 doors with option 3 drawers

width	height	depth	code
275	55	40	2D-3D with option 3L

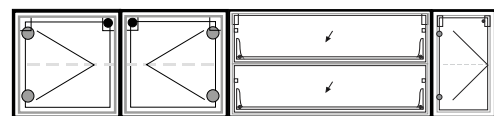

1 door 1 door 2 drawers 1 small door

width	height	depth	code
237,5	55	40	2D-LL-1SD

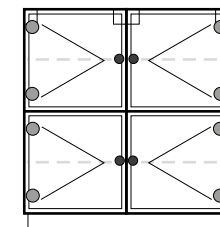

4 doors cabinet with base

width	height	depth
110	110	40

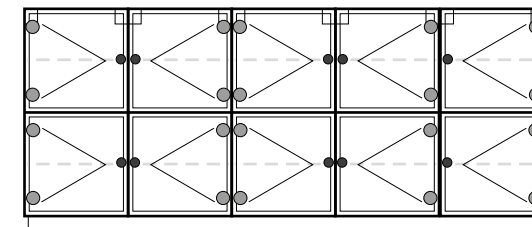

10 doors cabinet with base

width	height	depth
275	110	40

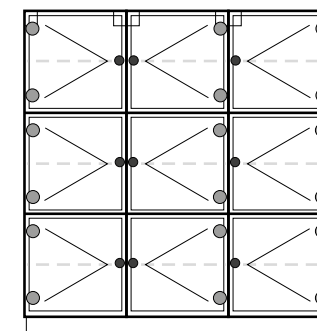

9 doors cabinet with base

width	height	depth
165	165	40

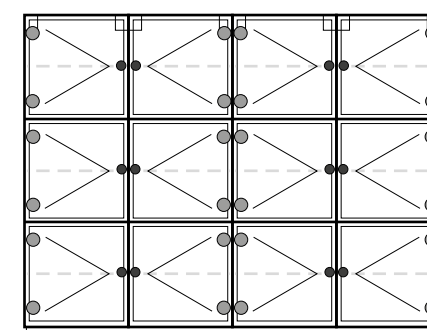

12 doors cabinet with base

width	height	depth
220	165	40

cube 70

Make the perfect combination with 70 x 70 cm blocks. The Cube 70 is only available as a standing cupboard, standard included with plinth.

[click here](#)

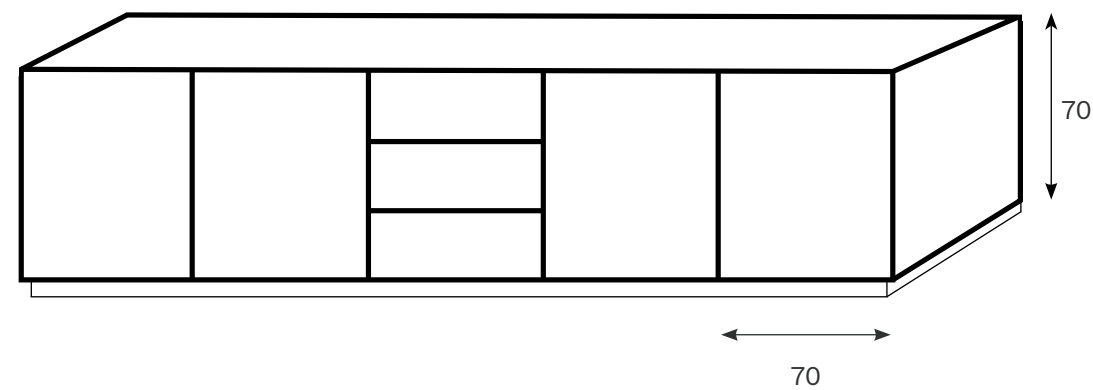

cube 70 in Matilux® black | fizz big round (150 cm) with table top Xeramica® black iron | marguerite armchairs with shell in vegan leather black



cube 70 in Matilux® white with 3 drawers and 1 small door

cube 70

Designed by Chris Vankeirsbilck

- hinge
- push point
- cabinet
- - - fixed partition
- > rotation direction

max. load 20 kg / door

elements

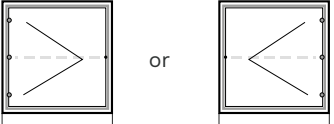
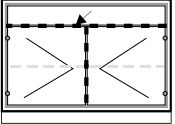
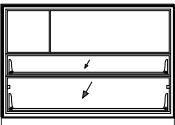
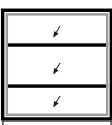
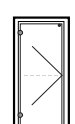
	width	height	depth	code
 or	70	78	40	1D
	110	78	40	LDD
	110	78	40	SLL
	70	78	40	3L
	30	78	40	1SD





options

1. Ceramic top



cube 70 examples

Designed by Chris Vankeirsbilck

-  hinge
-  push point
-  cabinet
-  fixed partition
-  rotation direction

max. load 20 kg / door

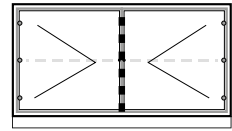

door door

width	height	depth	code
140	78	40	2D

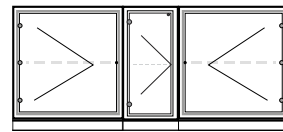

door small door door

width	height	depth	code
170	78	40	D-SD-D

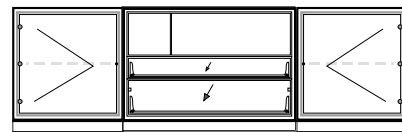

door space & 2 drawers door

width	height	depth	code
250	78	40	D-SLL-D

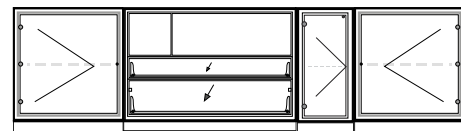

door space & 2 drawers small door door

width	height	depth	code
280	78	40	D-SLL-SD-D

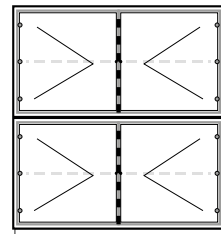

4 doors with base

width	height	depth	code
140	148	40	4D

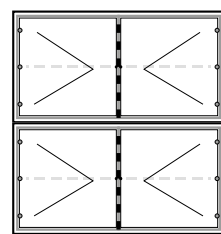

4 doors (hanging)

width	height	depth	code
140	140	40	4D

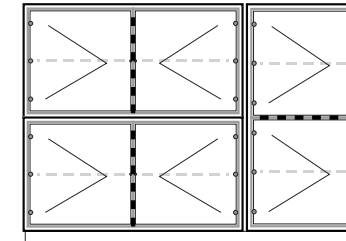

6 doors with base

width	height	depth	code
210	148	40	6D

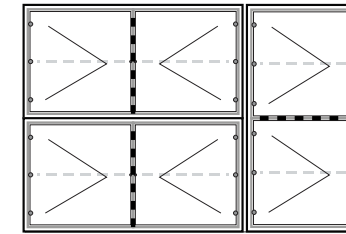

6 doors (hanging)

width	height	depth	code
210	140	40	6D

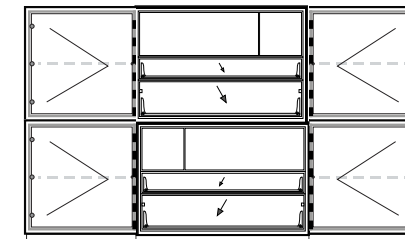

2 doors 2 x 1 space & 2 drawers 2 doors

width	height	depth	code
250	148	40	2D - 21SD - 2D

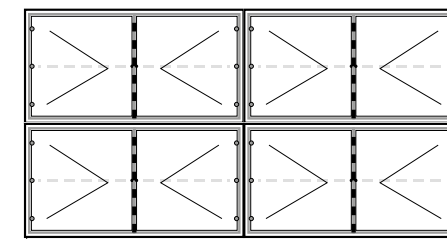

8 doors with base

width	height	depth	code
280	148	40	8D

cube 83

The Cube 83 consists of blocks of 83 x 55 cm. Combine several blocks from this collection to create your own customized cupboard. Cube 83 is only available as a standing option.

[click here](#)

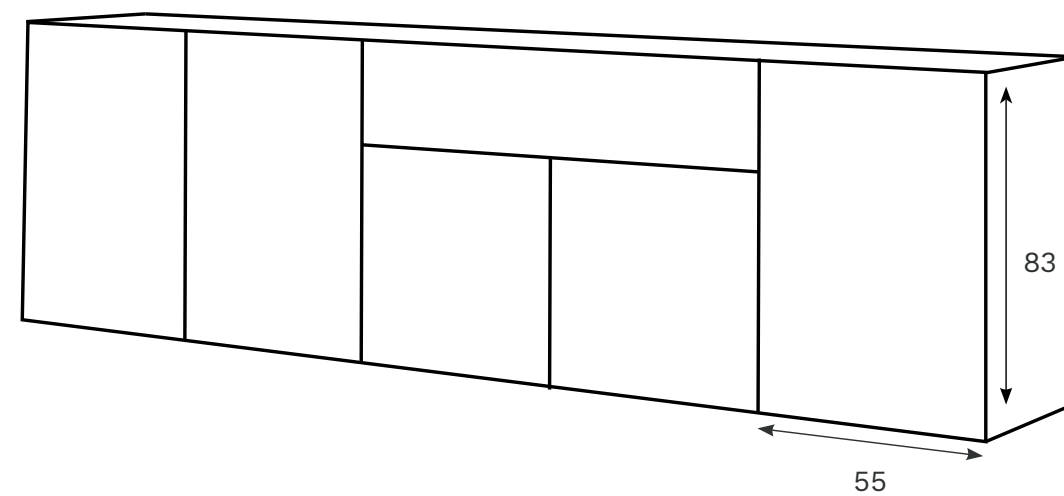



cube 83

Designed by Chris Vankeirsbilck

- hinge
 - push point
 - cabinet
 - - - fixed partition
 - > rotation direction
- max. load 20 kg / door*

elements

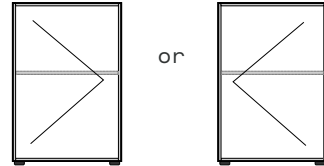
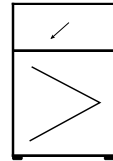
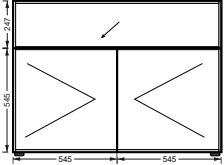
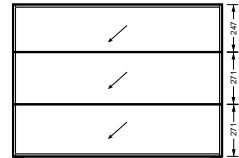
	width	height	depth	code
	55	83	50	1D
	55	83	50	LD
	110	83	50	LDD
	110	83	50	3L

options

1. base in Matilux® (height 8 cm)
(wooden frame finished with Matilux®
glass adjustable in height)
2. ceramic top

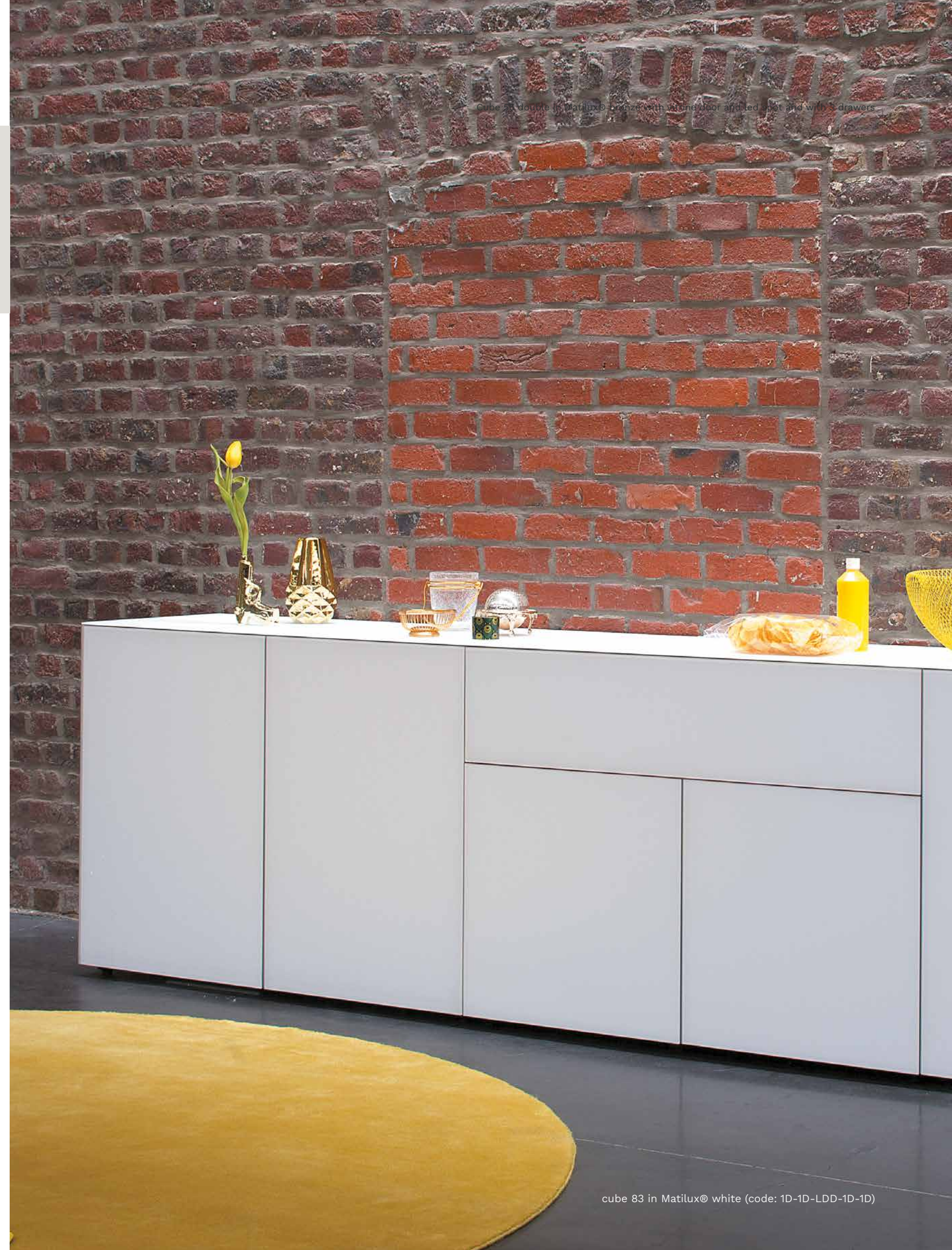

cube 83 in Matilux® white (code: 1D-1D-LDD-1D-1D)

cube 193

The largest in our cupboard collection: Cube 193. Choose 1, 2, 3 or 4 elements that you put together to form 1 big, beautiful standing cabinet.

[click here](#)

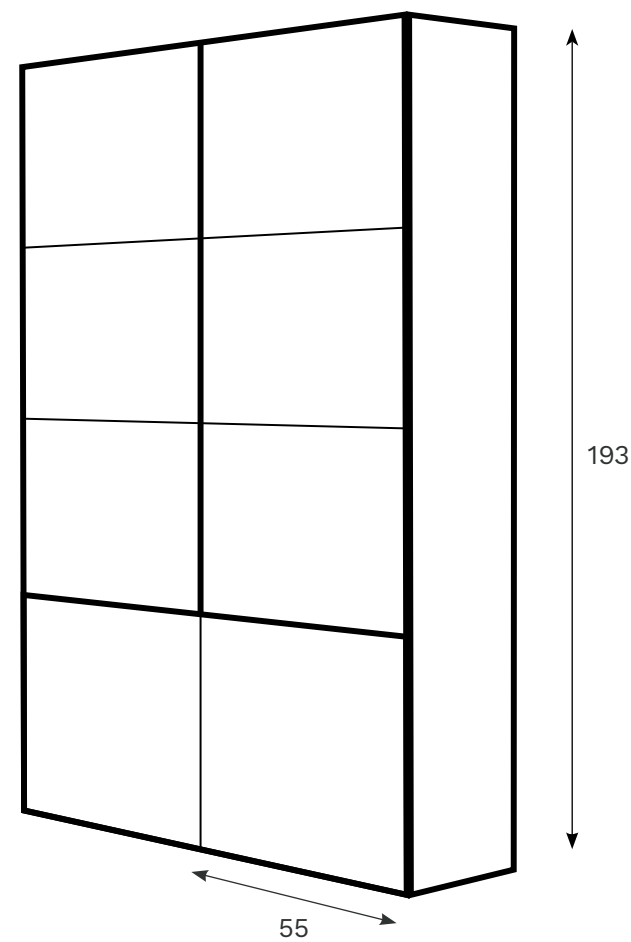

cube 193 in Matilux® white with inside old oak



cube 193

Designed by Chris Vankeirsbilck

element

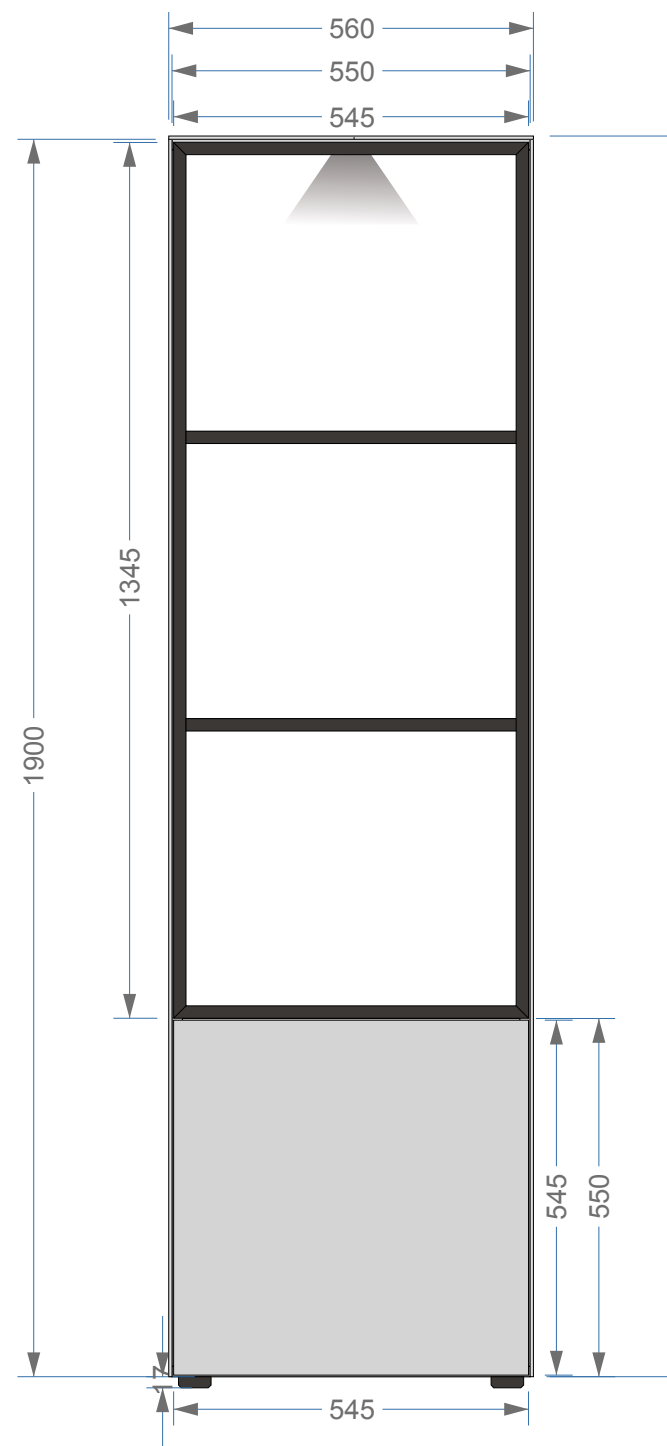

examples

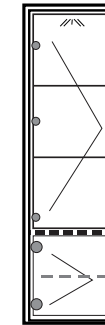

	width	height	depth	code
1 door	55	193	40	1D

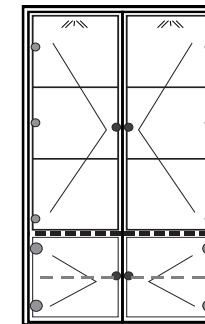

	width	height	depth	code
2 doors	110	193	40	2D

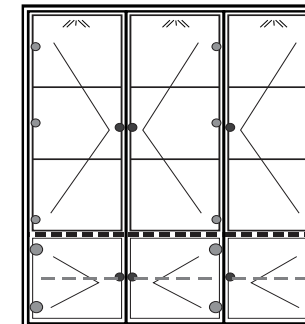

	width	height	depth	code
3 doors	165	193	40	2D

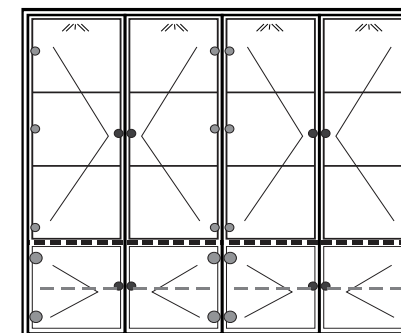

	width	height	depth	code
4 doors	220	193	40	2D

- hinge
- push point
- cabinet
- - - fixed partition
- > rotation direction

max. load 20 kg / door



our accessories

Side tables

Collins 180

Flower 186

Table accessories 194

Bite, Heatt & Turnable Disc

collins

This powder-coated aluminium side table was designed with outdoor use in mind. A small, light-weight design in two different heights. Prefer a tidy look? Simply slide the low Collins table under the higher version and put them aside.

[click here](#)



collins high & low in lino



collins high & low in lino | fizz low chair in rope solemio lino



collins high & low black | wire low chairs with cushions smooth ash



collins high in bronze | wire low chair in bronze

collins

indoor & outdoor

Designed by Mathias De Ferm

dimensions



	diameter	height	height table top till floor
high	44	66	56
low	44	56	46

frame

lacquered aluminium

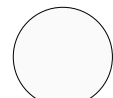

white



lino



taupe



bronze



anthracite



black



flower

Our newest side table: Flower. Just like a real flower, this flower table changes over time. You can move each table top – the flower's petals – to make a new composition. Brand new in the range of colors: bronze. Luxurious, trendy and timeless. This dynamic and playful table allows you to finish your work from a lounge chair or just makes your drink and snack easy to reach when you're chilling.

[click here](#)



nature is our biggest inspiration



flower side tables in bronze, black and lino





flower side table in lino

Just like nature,
the flower table shows
itself in different
colors and finishes



flower side table in bronze

flower

Designed by Mathias De Ferm

indoor & outdoor

dimensions

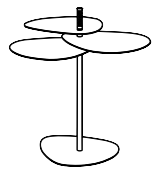

	height total	height petal 1	height petal 2	height petal 3	length petals	width petals
side table	76	64.5	61.5	58.5	45.0	40.5

frame

lacquered aluminium

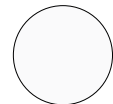

white



lino



taupe



bronze



anthracite



black



table accessories

Everything starts at the table. Who doesn't love evenings that slowly turn into the night while you're still picking from the food on the table. Especially for these occasions we have 3 types of table accessories: Heatt to keep your food warm, Bite which you can easily attach to your table to create more space and thanks to the Turnable Disc, everything is within reach.

[click here](#)



heatt dia 60 in Xeramica® black iron | marguerite round (dia 150 cm) with table top Xeramica® black iron | rafael x-base in vegan leather black



heatt 140 in Xeramica® black iron



heatt 21 in Xeramica® soft oak



bite large in oak | heatt 140 in Xeramica® black iron | layers dining table (300 cm) with table top Xeramica® black iron | fizz armchair in rope solemio charcoal

heatt 140 in Xeramica® caravaggio | curve faux elyps (300 cm) with table top Xeramica® caravaggio | curve chair in smooth tagine



meet the designers

cas moor lieven musschoot

Cas Moor graduated in 2015 with a bachelor's degree in Interior Architecture and a masters degree in Autonomous Design. His projects range from interior architecture, lighting, furniture and accessories to exhibitions and electronics.

Lieven Musschoot graduated as an Interior Architect from the Architecture school Sint-Lucas in Ghent, Belgium. He believes interior architecture is a reaction between the client and the architect.

Since 2014 Moor & Musschoots are a productdesign team. Their pilosophy is: "it's obvious that a designer listens to the machines."

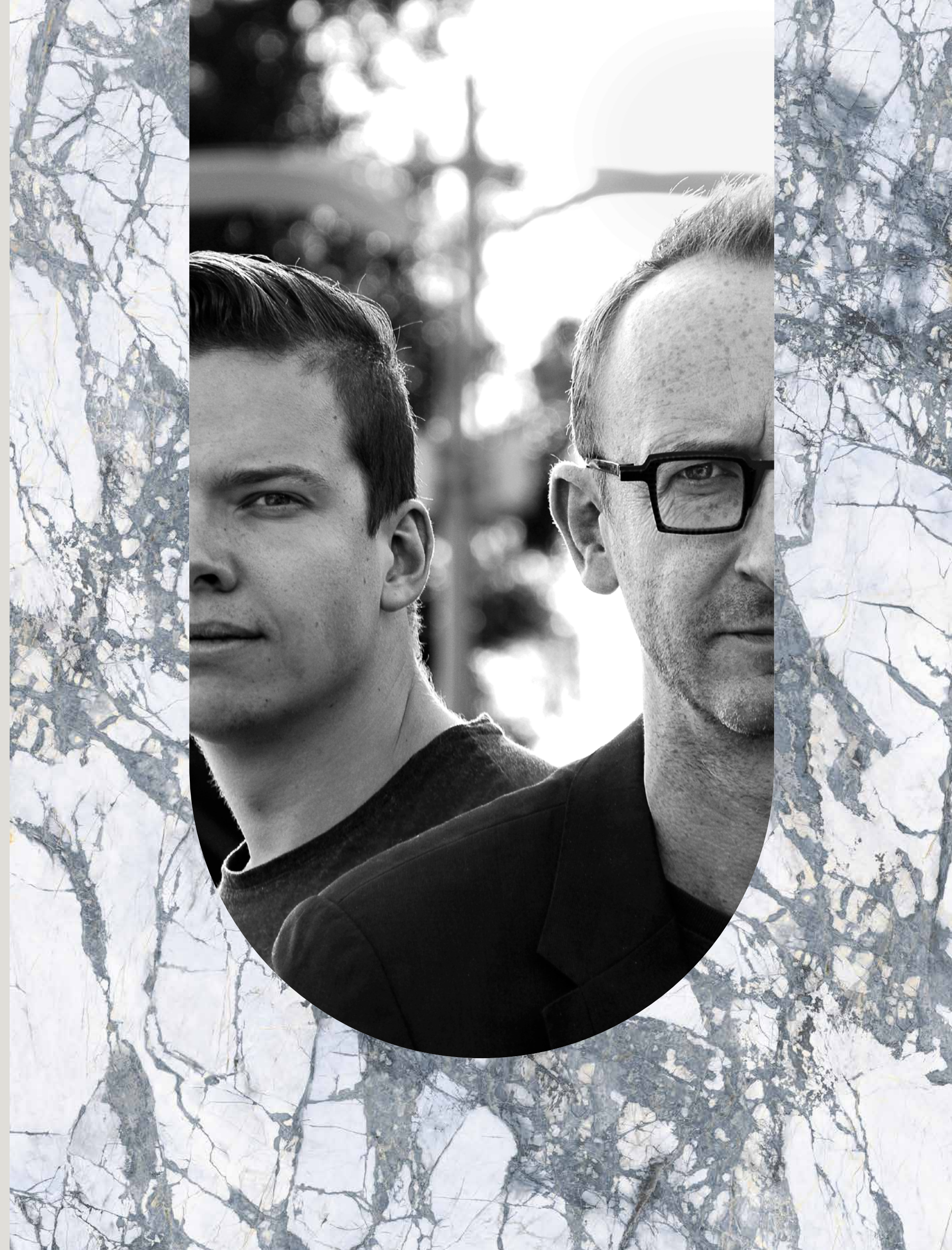

bringing people together



bite small in beech



turnable disc in Xeramica® emperador | marguerite round table (150 cm) with table top Xeramica® emperador | wire dining chairs with cushions smooth tagine

A good design is when a
object is stripped down
to its bare bones with
the essence still intact.



heatt 95 & heatt dia 21 in Xeramica® absolute white | bite small in oak | propeller dining table (300 cm) with table top Xeramica® absolute white | wire dining chairs with cushions smooth canvas

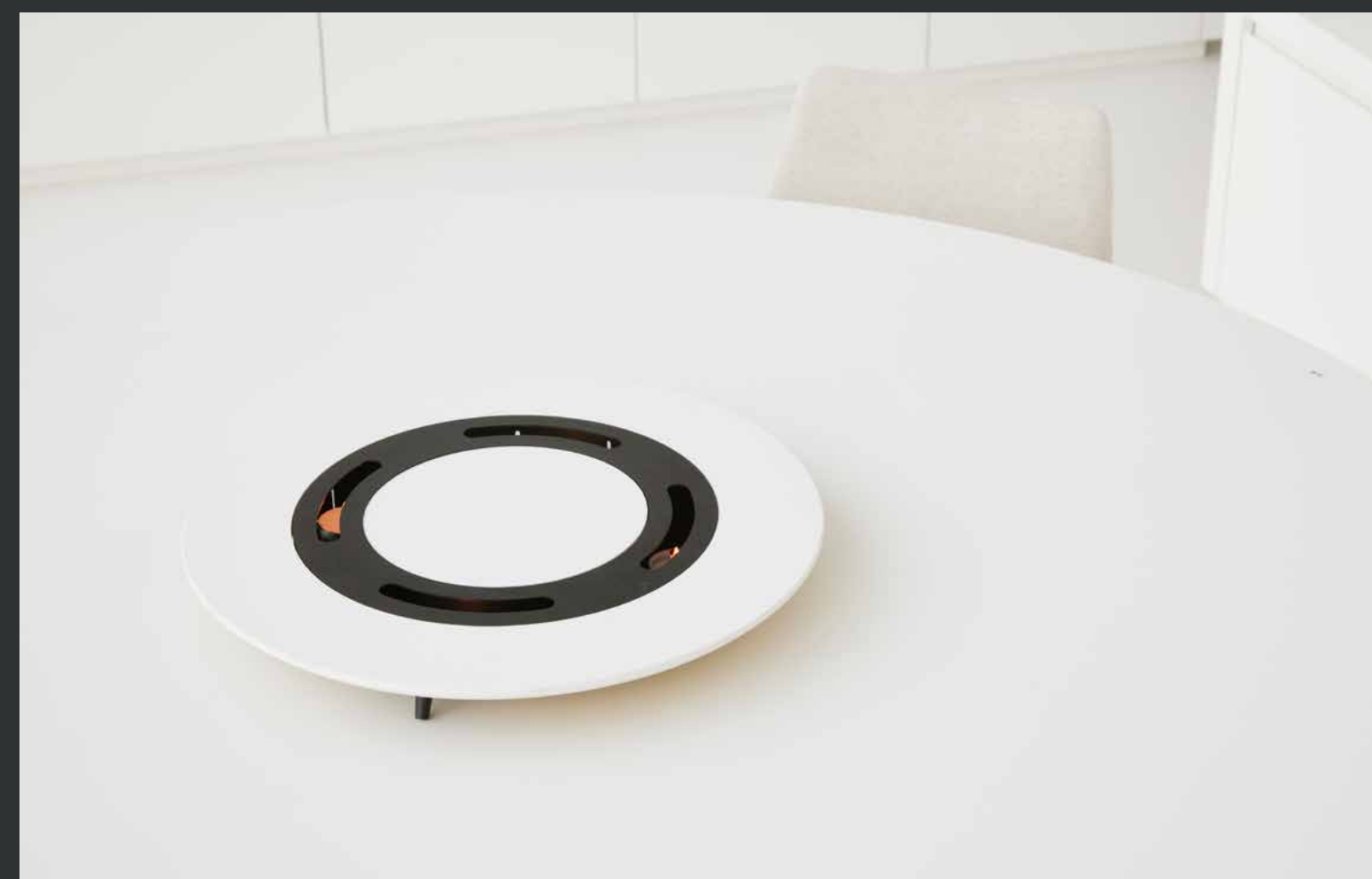

heatt dia 45 in Xeramica® absolute white

table accessories

indoor & outdoor

Designed by Cas Moor & Lieven Musschoot

dimensions

plate warmer oblong	length	width
heatt 140	140	20
heatt 95	95	20

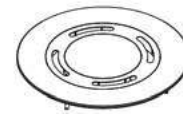

plate warmer round	diameter
heatt dia 60	60
heatt dia 45	45
heatt dia 21	21

side plate oblong	length	width
bite large	550	300



side plate round	diameter
bite small	35

turnable disc	diameter
disc 60	60
disc 45	45

wood for bite



oak



walnut



beech

ceramics for heatt and turnable disc

6 + 6 mm

Calacatta
only possible for
turnable disc

13 mm

Absolute white
Black iron
Caravaggio
Charisma grey

Emperador
Lava brown
Marble azuro
Marble marone

Soft oak
Travertino grey

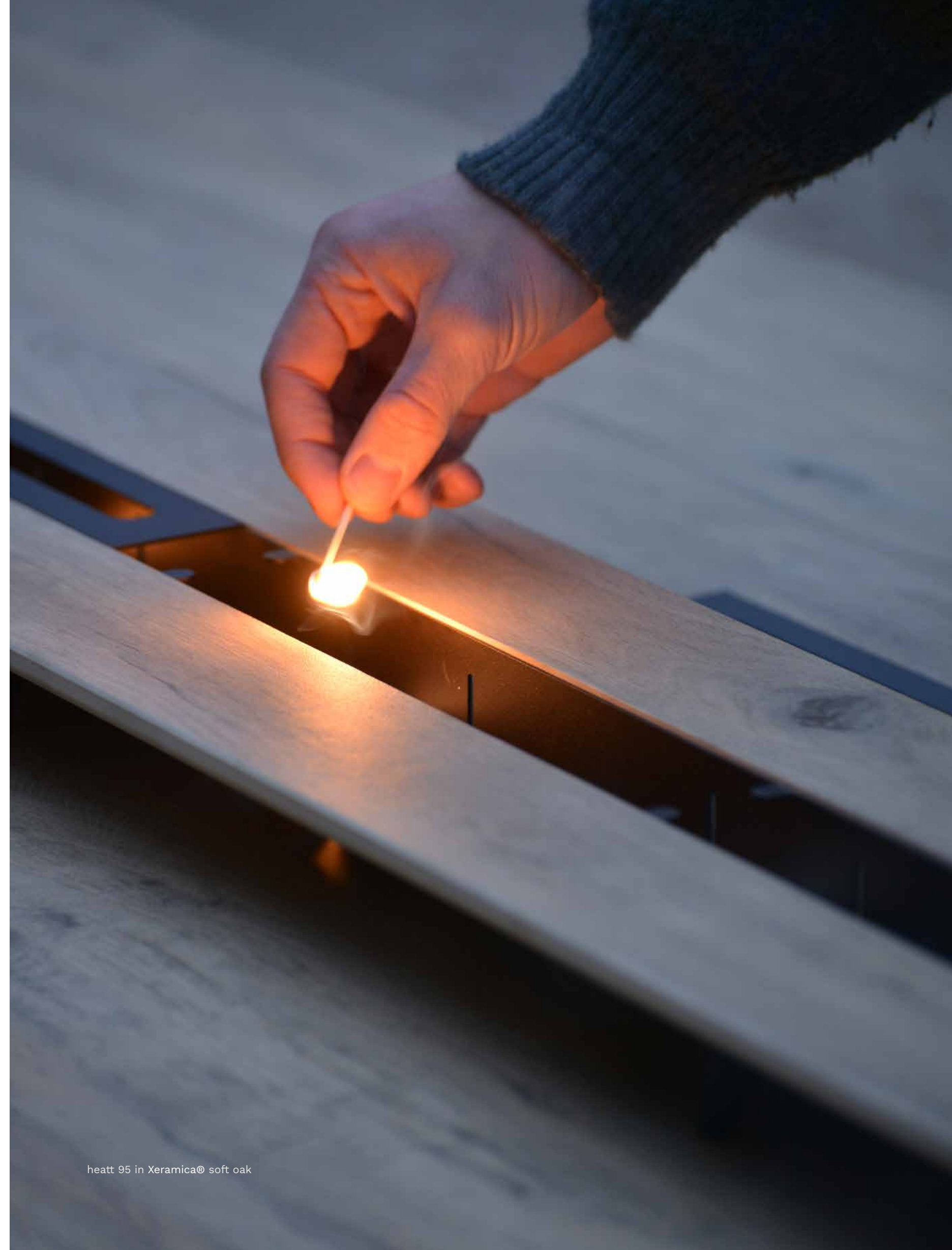

heatt 95 in Xeramica® soft oak

choice for quality

Surviving seasons and generations 210

Xeramica® 212

Fenix® 214

Matilux® 216

Fabrics 218

Maintenance 223



surviving seasons and generations



We believe in durability. Our furniture is designed to last. Robust, yet cosy. We always use stainless steel and aluminium for our tables and our table tops are made of Xeramica®, a product that is beautiful and practical.

Because of our choice for quality all our tables, accessories and loungers can be used both indoors and outdoors. This also applies to many of our chairs and their cushions.

indoor & outdoor





ceramic
table
tops.

xeramica[®]

The table tops are available in 11 different ceramic types.

Xeramica[®] consists of minerals that are compressed under high pressure and at a high temperature to create a very dense, homogeneous structure.

The advantages of Xeramica[®]:

- No scratches*
- 100% UV resistant
- Does not absorb fat, acid, water or wine
- 100% frost-resistant
- No visible dust
- Easy to maintain
- For indoors and outdoors

Xeramica[®] 6 + 6 mm

This is a 6 mm ceramic plate laminated to 6 mm tempered glass.

Xeramica[®] 13 mm

This is a full ceramic plate with a glass fibre membrane underneath.

* Caravaggio is more sensitive to scratches due to a high-gloss layer.



calacatta
6 + 6 mm

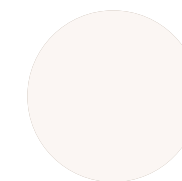

absolute white
13 mm



black iron
13 mm



caravaggio*
13 mm



charisma grey
13 mm



emperador
13 mm



lava brown
13 mm



marble azuro
13 mm



marble marone
13 mm



soft oak
13 mm

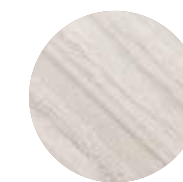

travertino grey
13 mm

[click here](#)

fenix[®]
for your
cabinets.

fenix[®]

Recently, we added FENIX[®] to our material range. This matte finish avoids fingerprints because of its nano-technology surface and guarantees timeless style. A perfect choice for your cabinet.

FENIX[®] products are made of paper (over 60%) and thermosetting resins (30 - 40%). The FENIX[®] products are created by a pressing process in which heat and pressure are applied simultaneously in order to obtain a homogeneous non-porous product.

The advantages of FENIX[®]:

- Low light reflectivity
- Extremely matt surface
- Anti-fingerprint
- Thermal healing of superficial microscratches

And finally, as an additional great benefit FENIX[®] innovative materials for interior design are carbon neutral!

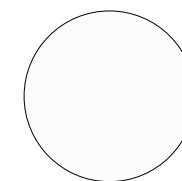

bianco kos
#0032



beige luxor
#0719

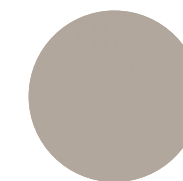

beige arizona
#0748

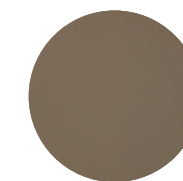

castora ottawa
#0717

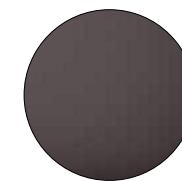

cacao orinoco
#0749

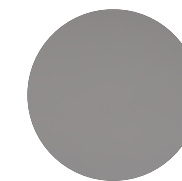

grigio efeso
#0725



grigio antrim
#0752

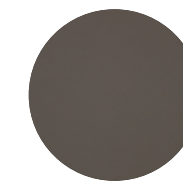

grigio londra
#0718

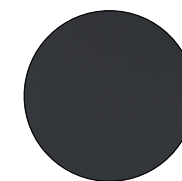

grigio bromo
#0724

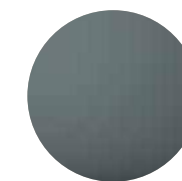

verde comodoro
#0750



rosso jaipur
#0751



blu fes
#0754

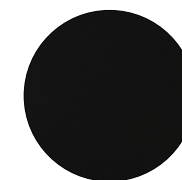

nero ingo
#0720

[click here](#)

matilux[®]
for your
cabinets.

matilux[®]

Matilux[®] is an extra clear glass, tempered, colored and frosted. Leavened on the top and colored on the bottom.

The advantages of Matilux[®]:

- No more greasy fingers
- No reflection in the sun
- No visible scratches
- Feels soft and warm
- The coat of paint on the underside is baked into the glass
- The glass is tempered
- No green or blue effect on the edge of the glass
- Easy maintenance, no streaks after polishing



black
4 mm



antracite
4 mm



dark brown
4 mm



taupe
4 mm

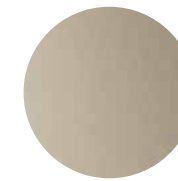

bronze
4 mm



lino
4 mm



white
4 mm



choose
your
fabric.

fabrics

With 7 different types and a total of 41 colours, there is plenty of choice in our fabrics.

Are you going for a new outdoor chair? Then choose nautic linen in 8 contemporary colours. Or go for Smooth, the fabric you would hardly believe is not only an indoor fabric, but also an outdoor one. As the name says, super soft!

We also have 5 interior fabrics. You can choose real leather or would you rather go for the equally beautiful vegan variant? Furthermore, we have easy care fabrics and corallo. Or go for more shine and a brighter colour with velvet.

[click here](#)

indoor

corallo

70% polyacryl, 20% polyester, 10% baumwolle

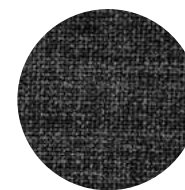

charcoal

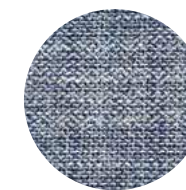

blue



cherry

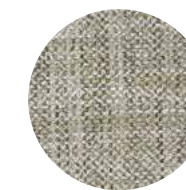

beige

easy care fabrics

100 % enhanced micro polyester chenille yarn



tobacco



truffle

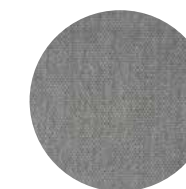

stone



flax

velvet

100 % polyester



black



beige

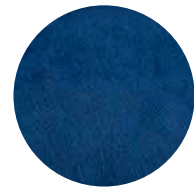

blue



green



orange

smooth

solution dyed polypropylene chenille (washable)



sooty

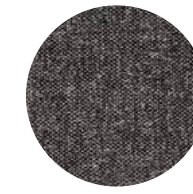

ash

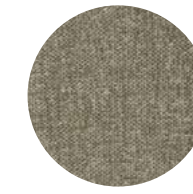

canvas



tagine

vegan leather

1% Polyurethane, 82% Polyvinyl Chloride, 17% Polyester



black



anthracite



dark brown

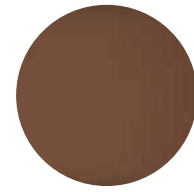

cognac

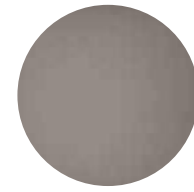

taupe

nautic linen

solution dyed polypropylene (washable)

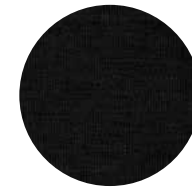

carbon

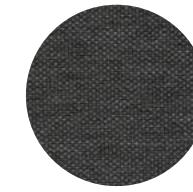

pepper

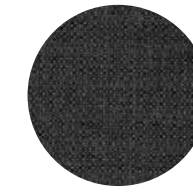

earth

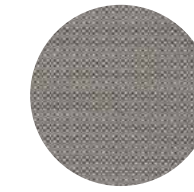

sand

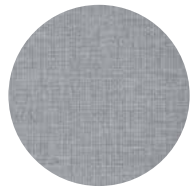

salt

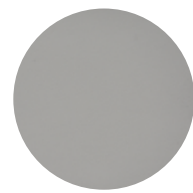

lino

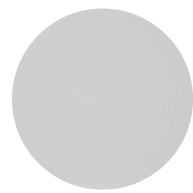

white



sahara

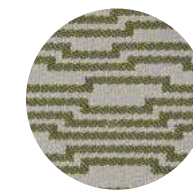

bamboo

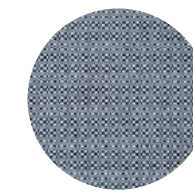

ocean

leather



black



anthracite



nutella

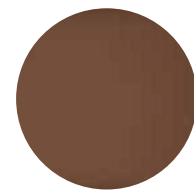

cognac

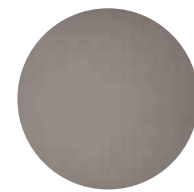

taupe

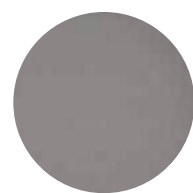

pearl



grey



beige

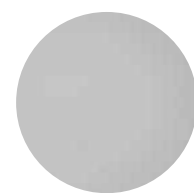

white

eat. play. talk.
think. work.

maintenance

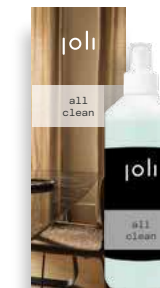

all clean

Powerful, versatile and safe cleaner for all applications, indoor and outdoor. Removes grease, dirt and green soiling. Cleans: garden furniture, fenix, vegan leather, table tops, textile fabric covers and tarpaulin.

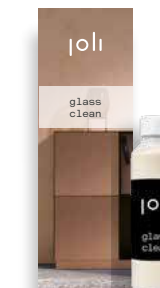

glass clean

Glass clean does not leave scratches and is therefore most suitable for cleaning matt glass, ceramics or stainless steel. This makes it the perfect agent for treating aggressive grease marks or tough dirt on Matilux®, even surface rust on stainless steel (brown spots).



textile protector

High-performance protection product for upholstery textiles. The dirt-repellent layer means that food and drinks will not leave stains. This will ensure that your furniture lasts for many years without stains.

find our dealers

We work together with dealers in 19 countries, all over the world. Want to know where? Click on this button.

[click here](#)

Photography: SKINN, Beeldcollectief,
Frederik Vercruysse, Mathias De Ferm & Bieffe

Design: Unik Concepts

Joli Head office
Industrielaan 5, 8520 Kurne - Belgium
Tel. +32 (0)56 37 27 16
info@joli.be
www.joli.be

Want to see more of Joli?
Follow us on:

