

2022

listino / pricelist / preislite /
liste de prix / lista de precios

phormalab
INFRAREDS

MADE IN ITALY





HOTDOOR

Dalla ricerca e dalla secolare esperienza nella lavorazione dei metalli, nasce il Progetto Hotdoor, con il quale la tradizione manifatturiera incontra il design.

Il risultato è un riscaldatore a raggi infrarossi, ideale per l'esterno, solido e funzionale e, al tempo stesso, dal design raffinato ed elegante.

From a secular experience in metalworking, arises Hotdoor Project, where the manufacturing tradition meets design. The result is an infrared heater, ideal for outdoor use, solid and functional and, at the same time, with a refined and elegant design.

da Pag. 4

aura

Phormalab presenta AURA, la nostra nuova lampada dal design essenziale e dallo stile urbano, che va a integrare la nostra gamma di prodotti.

Frutto di un accurato lavoro di ricerca, AURA affianca un'estetica all'avanguardia ad un'elevata funzionalità ed innovazione tecnologica, lanciando uno sguardo verso il futuro del settore del riscaldamento ad infrarossi.

Phormalab is proud to present AURA, our newest infrared lamp. Characterised by an essential design and an urban style, it fits perfectly among our selection of products. Derived from a deep research work, AURA implements modern aesthetics to exceptional functionality and technological innovation, embracing a vision towards the future in the field of infrared heating lamps.

da Pag. 35

hotdoor



DESIGN E QUALITÀ MADE IN ITALY

design and quality made in Italy / design und qualität made in Italy /
design et qualite made in Italy / diseño y calidad made in Italy

HOTDOOR [PATENTED] DESIGN BY ANTONIO DI CHIANO

IT

DESIGN: Disegnato e prodotto in Italia
MATERIALI: Corpo e supporti in alluminio pressofuso
DURATA DELLA LAMPADINA: 5.000 ore circa
GRADO DI PROTEZIONE: IP44 (la lampada è utilizzabile anche in spazi esterni e resiste agli spruzzi d'acqua)
POTENZE DISPONIBILI: 1500, 2000 W
ALIMENTAZIONE: 230 V – 50/60 Hz (disponibile anche 110 V)
ENERGIA ASSORBITA: Oltre il 90% dell'energia assorbita viene emessa sottoforma di raggi infrarossi
ORIENTAMENTO: Fascio scaldante
GAMMA: Con attacco a parete o a soffitto, con piantana, singola e doppia
COLORI CORPO LAMPADA E ACCESSORI: Nero, bianco e beige
COLORI FRONTALE: Nero, bianco, grigio, ottone, beige, argento



EN

DESIGN: Designed and manufactured in Italy
MATERIALS: Heater body and accessories in die-casting aluminum
BULB LIFE: about 5.000 hours
PROTECTION LEVEL: IP44 (the lamp can be used outdoors and assures perfect impermeability against water sprinkling)
AVAILABLE POWERS: 1500, 2000 W
POWER SUPPLY: 230 V – 50/60 Hz (available 110 V)
ABSORBED ENERGY: More than 90% of the absorbed energy is radiated as infrared emission
ORIENTATION: Adjustable heating beam
RANGE: Wall mounting, ceiling mounting, floor stem
COLORS HEATER BODY AND ACCESSORIES: Black, white or grey
COLORS FRONT COVER: Black, white, grey, brass, beige, silver



DE

DESIGN: Italienisches Design und hergestellt in Italien
MATERIALIEN: Strahlerkörper und Zubehöre aus Pressgussaluminium
DAUER DES HEIZELEMENTS: 5.000 Stunden ungefähr
SCHUTZART: IP44 (Strahler nutzbar in Außerräumen und Spritwasser- und Regenfest)
VERFÜGBARE LEISTUNGEN: 1500, 2000 W
STROMZUFUHR: 230 V – 50/60 Hz (verfügbar 110 V)
ABSORBIERTEN ENERGIE: Über 90% der absorbierten Energie strahlt als Infra-rotstrahlung aus
ORIENTIERUNG: Einstellbarer Heizstrahl
VERFÜGBARE LÖSUNGEN: Wandhalterung, Deckenhalterung, Fußbodenständer
VERFÜGBARE FARBEN KÖRPER UND BEFESTIGUNGSELEMENTE: Schwarz, Weiß oder Grau
VERFÜGBARE FARBEN VORABDECKUNG: Schwarz, Weiß, Grau, Messing, Beige, Silber



FR

DESIGN: Design et production italienne
MATÉRIELS: Corps de la lampe et accessoires en aluminium moulé sous pression
DURÉE DE L'AMPOULE : 5.000 heures a peu près
PROTECTION: IP44 (la lampe peut être utilisée à l'extérieur et est imperméable aux jets d'eau et à la pluie)
PUISSANCES DISPONIBLES: 1500, 2000 W
ALIMENTATION: 230 V – 50/60 Hz (disponible aussi 110 V)
ÉNERGIE ABSORBÉE: Plus que 90% de l'énergie absorbée vient réémise comme radiation infrarouge
ORIENTATION: Lampe orientable
SOLUTIONS: Appliques, plafonniers, lampadaires
COULEURS DISPONIBLES CORPS DE LA LAMPE ET ACCESSOIRES: Blanc, noire ou gris
COULEURS DISPONIBLES COUVERTURE ANTÉRIEURE: Noir, blanc, gris, laiton, beige, argent



ES

DESIGN: Diseñada y producida en Italia
MATERIALES: Cuerpo y accesorios de aluminio vaciado a presión
DURACIÓN DE LA BOMBILLA: 5.000 horas aproximadamente
GRADO DE PROTECCIÓN: IP44 (la lámpara puede ser utilizada al exterior, resistente a las salpicaduras de agua y a la lluvia)
POTENCIAS DISPONIBLES: 1500, 2000 W
ALIMENTACIÓN: 230 V – 50/60 Hz (110 V también disponible)
ENERGÍA ABSORBIDA: Más del 90% de la energía absorbida es emitida en forma de radiación infrarroja
ORIENTACIÓN: Haz de rayos infrarrojos regulable
GAMA: Soporte a pared o techo, de pie, individuales y dobles
COLORES CUERPO, DE LA LÁMPARA Y ACCESORIOS: Negro, blanco o gris
COLORES COBERTURA ANTERIOR: Negro, blanco, gris, bronce, beige, plata



hotdoor

VERSIONI

versions / kompositionen /
compositions / composiciones



PARETE

wall / wand / murale / pared



P 12 – 17

SOFFITTO

ceiling / decke / plafonnier / techo



P 18 – 21

SINGOLA

single / einzel / single / individual

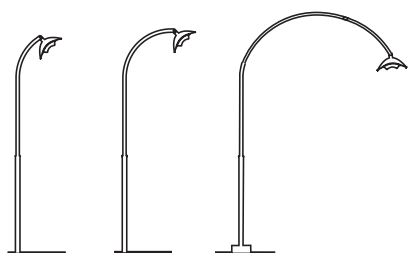

P 22 – 27

DOPPIA

double / doppel / double / doble

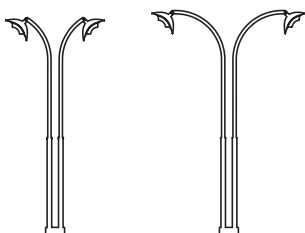

P 28 – 31



COLORI

colors / farben /
couleurs / colores



CORPI

bodies / körper / corps / cuerpos



 **NERO**
black / schwarz / noir / negro

 **BEIGE**
beige / beige / beige / beige

 **BIANCO**
white / weiß / blanc / blanco

SCOCICHE

shells / abdeckungen / couvertures / cubiertas

 **NERO**
black / schwarz / noir / negro

 **BIANCO**
white / weiß / blanc / blanco

 **BEIGE**
beige / beige / beige / beige

 **GRIGIO**
grey / grau / gris / gris

 **ARGENTO**
silver / Silber / argent / plata

 **OTTONE**
brass / Messing / laiton / bronze



DIMMER BASIC DIM01

RICEVITORE WIRELESS INFRAROSSI + TELECOMANDO (TEL01)

infrared-wireless receiver + remote control (TEL01)
 infrarot-wireless empfänger + Fernbedienung (TEL01)
 infrarouge-sans fil récepteur + télécommandé (TEL01)
 receptor inalámbrico infrarrojos + mando a distancia (TEL01)

- 2000W** | **POTENZA MAX**
power / Leistung /
puissance / potencia
- 230V** | **ALIMENTAZIONE**
power supply / stromzufuhr /
alimentation / alimentación
- FROM 50% TO 100%** | **LIVELLI DI FUNZIONE**
operating levels / laufstufen /
niveaux de fonction / niveles de función
- 20° C** | **TEMPERATURA MIN - MAX**
+50° C | temperature min-max / temperatur min-max /
temperature min-max / temperatura min-max /
- IP54** | **GRADO DI PROTEZIONE**
degree of protection / schutzstufe /
degré de protection / grado de protección
- 145x115x55** | **DIMENSIONI [mm]**
sizes [mm] / maße [mm] /
dimensions [mm] / dimensiones [mm]
- NO PLUG** |



DIMMER SMART DIM03

RICEVITORE INFRAROSSI - TELECOMANDO/BLUETOOTH*

infrared-bluetooth* receiver
 infrarot-bluetooth* empfänger
 infrarouge-bluetooth* récepteur sans fil
 receptor inalámbrico infrarrojos bluetooth*

- 3000W** | **POTENZA MAX**
power / Leistung /
puissance / potencia
- 220V - 230V** | **ALIMENTAZIONE**
power supply / stromzufuhr /
alimentation / alimentación
- FROM 0% TO 100%** | **LIVELLI DI FUNZIONE**
operating levels / laufstufen /
niveaux de fonction / niveles de función
- 20° C** | **TEMPERATURA MIN - MAX**
+50° C | temperature min-max / temperatur min-max /
temperature min-max / temperatura min-max /
- IP44** | **GRADO DI PROTEZIONE**
degree of protection / schutzstufe /
degré de protection / grado de protección
- 118x115x52** | **DIMENSIONI [mm]**
sizes [mm] / maße [mm] /
dimensions [mm] / dimensiones [mm]
- PLUG** | **UE - UK - CH - US**



* SMARTPHONE [IOS/ANDROID]
BLUETOOTH DIMMER



SPINE DISPONIBILI

plug / Stecker / Prise de courant / Enchufe

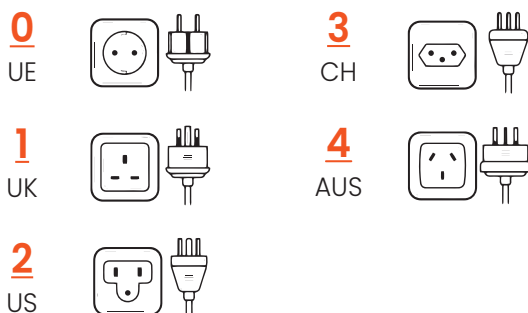





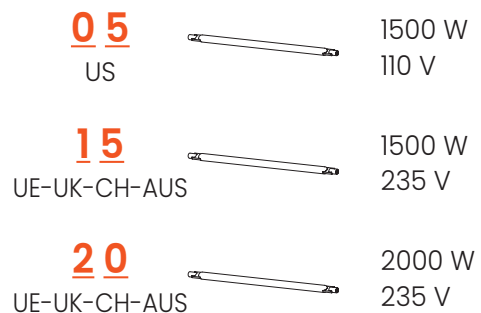



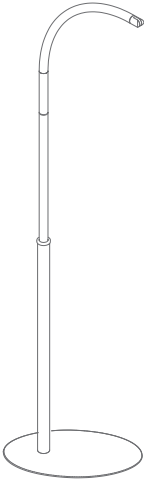

POTENZA

power / Leistung / Puissance / Potencia



ESEMPIO DI COME CREARE IL CODICE

example of how to create your code / Beispiel für die Code-Erstellung / exemple de création de code / ejemplo para la creación del código

MODELLO Model / Modell Modèle / Modelo	COLORE CORPO Body color / Farbe Körper Couleur corp / Color cuerpo	COLORE COVER Cover color / Farbe Bedeckung / Couleur couverture / Color cubierta	DIMMER Dimmer / Dimmer Gradateur / Regulador	SPINA Plug / Stecker / Prise de courant / Enchufe	POTENZA Power / Leistung Puissance / Potencia
	01 BLACK 	01 BLACK 	0 NO DIMMER	0 UE	05 1500 W* 110 V (US)
	02 WHITE 	02 WHITE 	1 DIMMER BASIC* 235 V (UE-UK-CH-AUS)	1 UK	15 1500 W* 235 V (UE-UK-CH-AUS)
	06 BEIGE* 	03 SILVER* 	2 DIMMER SMART* 110 V (US)	2 US	20 2000 W 235 V (UE-UK-CH-AUS)
		04 BRASS* 	3 DIMMER SMART* 235 V (UE-UK-CH)	3 CH	
		05 GREY* 		4 AUS **	
		06 BEIGE 			
HCA02	0 1	0 3	1	0	2 0

ESEMPIO DI COME CALCOLARE IL PREZZO

example of how to calculate the price / Beispiel für die Berechnung des Preises / exemple pour calculer le prix / ejemplo de cómo calcular el precio

PREZZO

price / prix / preis / precio

Da aggiungere al prezzo base / To add to standard price / Zum Basispreis hinzufügen / Ajouter au prix de base / Añadir al precio base*
solo con NO DIMMER o DIMMER BASIC / only with NO DIMMER or DIMMER BASIC / Nur mit KEIN DIMMER oder DIMMER BASIC / seul avec NO DIMMER ou DIMMER BASIC / sólo con NO DIMMER o DIMMER BASIC **

EXTRA:

- COVER SILVER



- DIMMER BASIC



PREZZO TOTALE:

total price / prix total / gemeinsampreis / precio total

hotdoor











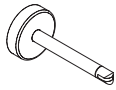

ATTACCO SINGOLO A PARETE

single wall mounting / kurze einzelwandhalterung /
applique murale / soporte a pared



CONFIGURA LA TUA HOTDOOR

Customize your Hotdoor / Konfigurieren Sie Ihre Hotdoor / Configure ton Hotdoor / Configura tu Hotdoor

MODELLO Model / Modell Modèle / Modelo	COLORE CORPO Body color / Farbe Körper Couleur corp / Color cuerpo	COLORE COVER Cover color / Farbe Bedeckung / Couleur couverture / Color cubierta	DIMMER Dimmer / Dimmer Gradateur / Regulador	SPINA Plug / Stecker / Prise de courant / Enchufe	POTENZA Power / Leistung Puissance / Potencia
 HAA01	01 BLACK 	01 BLACK 	0 NO DIMMER	0 UE	05 1500 W* 110 V (us)
	02 WHITE 	02 WHITE 	1 DIMMER BASIC* 235 V (UE-UK-CH-AUS)	1 UK	15 1500 W* 235 V (UE-UK-CH-AUS)
	06 BEIGE* 	03 SILVER* 	2 DIMMER SMART* 110 V (us)	2 US	20 2000 W 235 V (UE-UK-CH-AUS)
		04 BRASS* 	3 DIMMER SMART* 235 V (UE-UK-CH)	3 CH	
		05 GREY* 		4 AUS**	
		06 BEIGE 			

PREZZO

price / prix / preis / precio

Da aggiungere al prezzo base / To add to standard price / Zum Basispreis hinzufügen / Ajouter au prix de base / Añadir al precio base*
solo con NO DIMMER o DIMMER BASIC / only with NO DIMMER or DIMMER BASIC / Nur mit KEIN DIMMER oder DIMMER BASIC / seul avec NO DIMMER ou DIMMER BASIC / sólo con NO DIMMER o DIMMER BASIC**

DIMENSIONI [mm]

dimensions / abmessungen / dimension / dimensiones

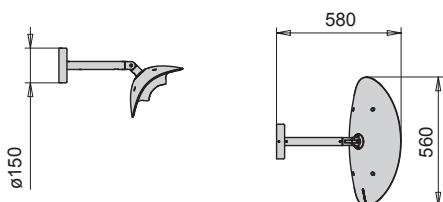

IMBALLO [mm]

packaging / verpackung / emballage / embalaje

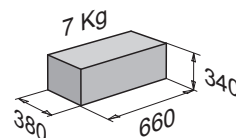













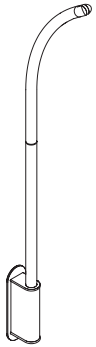

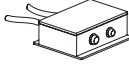
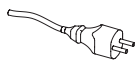
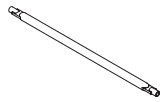





hotdoor

ATTACCO A PARETE CON STELO CORTO

wall stem with short arc / einzelwandhalterung mit kurzem bogen
applique murale avec tige arc court / soporte a pared con arco corto

CONFIGURA LA TUA HOTDOOR

Customize your Hotdoor / Konfigurieren Sie Ihre Hotdoor / Configure ton Hotdoor / Configura tu Hotdoor

MODELLO Model / Modell Modèle / Modelo	COLORE CORPO Body color / Farbe Körper Couleur corp / Color cuerpo	COLORE COVER Cover color / Farbe Bedeckung / Couleur couverture / Color cubierta	DIMMER Dimmer / Dimmer Gradateur / Regulador	SPINA Plug / Stecker / Prise de courant / Enchufe	POTENZA Power / Leistung Puissance / Potencia
 HAA11	01 BLACK 	01 BLACK 	0 NO DIMMER 	0 UE 	05 1500 W* 110 V (us) 
	02 WHITE 	02 WHITE 	1 DIMMER BASIC* 235 V (UE-UK-CH-AUS) 	1 UK 	15 1500 W* 235 V (UE-UK-CH-AUS) 
	06 BEIGE* 	03 SILVER* 	2 DIMMER SMART* 110 V (us) 	2 US 	20 2000 W 235 V (UE-UK-CH-AUS) 
		04 BRASS* 	3 DIMMER SMART* 235 V (UE-UK-CH) 	3 CH 	
		05 GREY* 		4 AUS** 	
		06 BEIGE 			

PREZZO

price / prix / preis / precio

Da aggiungere al prezzo base / To add to standard price / Zum Basispreis hinzufügen / Ajouter au prix de base / Añadir al precio base*
solo con NO DIMMER o DIMMER BASIC / only with NO DIMMER or DIMMER BASIC / Nur mit KEIN DIMMER oder DIMMER BASIC / seul avec NO DIMMER ou DIMMER BASIC / sólo con NO DIMMER o DIMMER BASIC**

DIMENSIONI [mm]

dimensions / abmessungen / dimension / dimensiones

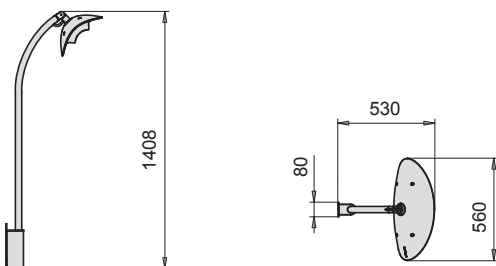

IMBALLO [mm]

packaging / verpackung / emballage / embalaje

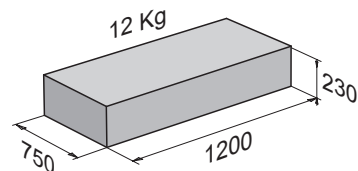

Per la creazione del codice, vedi l'esempio a pagina 11. - To create your code, see example at page 11. - Zur Erstellung des codes siehe Beispiel auf Seite 11.
Pour la création du code, voir l'exemple à la page 11. - Para la creación del código, vea el ejemplo en la página 11.

hotdoor











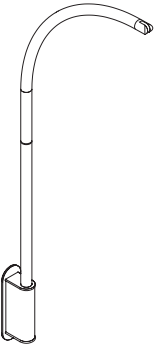

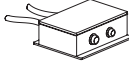
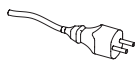
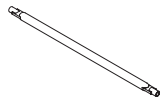
ATTACCO A PARETE CON STELO MEDIO

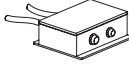
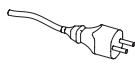
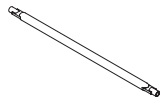
wall stem with medium arc / einzelwandhalterung mit mittlerem bogen
applique murale avec tige arc moyen / soporte a pared con arco medio

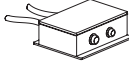
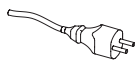
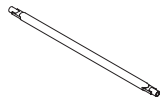

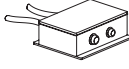
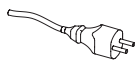
CONFIGURA LA TUA HOTDOOR

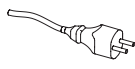
Customize your Hotdoor / Konfigurieren Sie Ihre Hotdoor / Configure ton Hotdoor / Configura tu Hotdoor

MODELLO Model / Modell Modèle / Modelo	COLORE CORPO Body color / Farbe Körper Couleur corp / Color cuerpo	COLORE COVER Cover color / Farbe Bedeckung / Couleur couverture / Color cubierta	DIMMER Dimmer / Dimmer Gradateur / Regulador	SPINA Plug / Stecker / Prise de courant / Enchufe	POTENZA Power / Leistung Puissance / Potencia
 <p>HAA12</p>	01 BLACK 	01 BLACK 	0 NO DIMMER 	0 UE 	05 1500 W* 110 V (us) 
	02 WHITE 	02 WHITE 	1 DIMMER BASIC* 235 V (UE-UK-CH-AUS) 	1 UK 	15 1500 W* 235 V (UE-UK-CH-AUS) 
	06 BEIGE* 	03 SILVER* 	2 DIMMER SMART* 110 V (us) 	2 US 	20 2000 W 235 V (UE-UK-CH-AUS) 
		04 BRASS* 	3 DIMMER SMART* 235 V (UE-UK-CH) 	3 CH 	
		05 GREY* 		4 AUS** 	
		06 BEIGE 			

PREZZO

price / prix / preis / precio

Da aggiungere al prezzo base / To add to standard price / Zum Basispreis hinzufügen / Ajouter au prix de base / Añadir al precio base*
solo con NO DIMMER o DIMMER BASIC / only with NO DIMMER or DIMMER BASIC / Nur mit KEIN DIMMER oder DIMMER BASIC / seul avec NO DIMMER ou DIMMER BASIC / sólo con NO DIMMER o DIMMER BASIC **

DIMENSIONI [mm]

dimensions / abmessungen / dimension / dimensiones

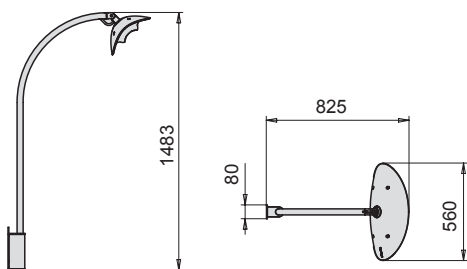

IMBALLO [mm]

packaging / verpackung / emballage / embalaje

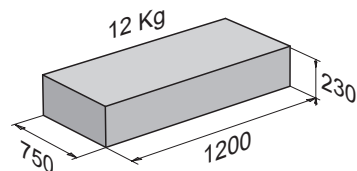

Per la creazione del codice, vedi l'esempio a pagina 11. - To create your code, see example at page 11. - Zur Erstellung des codes siehe Beispiel auf Seite 11.
Pour la création du code, voir l'exemple à la page 11. - Para la creación del código, vea el ejemplo en la página 11.

hotdoor









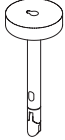

ATTACCO SINGOLO A SOFFITTO

ceiling single mounting / deckenhalterung /
plafonnier simple / soporte solo a techo



CONFIGURA LA TUA HOTDOOR

Customize your Hotdoor / Konfigurieren Sie Ihre Hotdoor / Configure ton Hotdoor / Configura tu Hotdoor

MODELLO Model / Modell Modèle / Modelo	COLORE CORPO Body color / Farbe Körper Couleur corp / Color cuerpo	COLORE COVER Cover color / Farbe Bedeckung / Couleur couverture / Color cubierta	DIMMER Dimmer / Dimmer Gradateur / Regulador	SPINA Plug / Stecker / Prise de courant / Enchufe	POTENZA Power / Leistung Puissance / Potencia
 HBA01	01 BLACK 	01 BLACK 	0 NO DIMMER	0 UE	05 1500 W* 110 V (us)
	02 WHITE 	02 WHITE 	1 DIMMER BASIC* 235 V (UE-UK-CH-AUS)	1 UK	15 1500 W* 235 V (UE-UK-CH-AUS)
	06 BEIGE* 	03 SILVER* 	2 DIMMER SMART* 110 V (us)	2 US	20 2000 W 235 V (UE-UK-CH-AUS)
		04 BRASS* 	3 DIMMER SMART* 235 V (UE-UK-CH)	3 CH	
		05 GREY* 		4 AUS**	
		06 BEIGE 			

PREZZO

price / prix / preis / precio

Da aggiungere al prezzo base / To add to standard price / Zum Basispreis hinzufügen / Ajouter au prix de base / Añadir al precio base*
solo con NO DIMMER o DIMMER BASIC / only with NO DIMMER or DIMMER BASIC / Nur mit KEIN DIMMER oder DIMMER BASIC / seul avec NO DIMMER ou DIMMER BASIC / sólo con NO DIMMER o DIMMER BASIC**

DIMENSIONI [mm]

dimensions / abmessungen / dimension / dimensiones

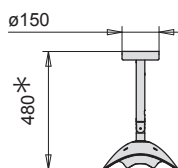
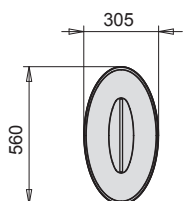

* On request
min 350-max 1200

IMBALLO [mm]

packaging / verpackung / emballage / embalaje

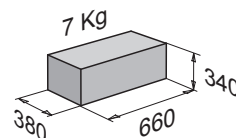

hotdoor





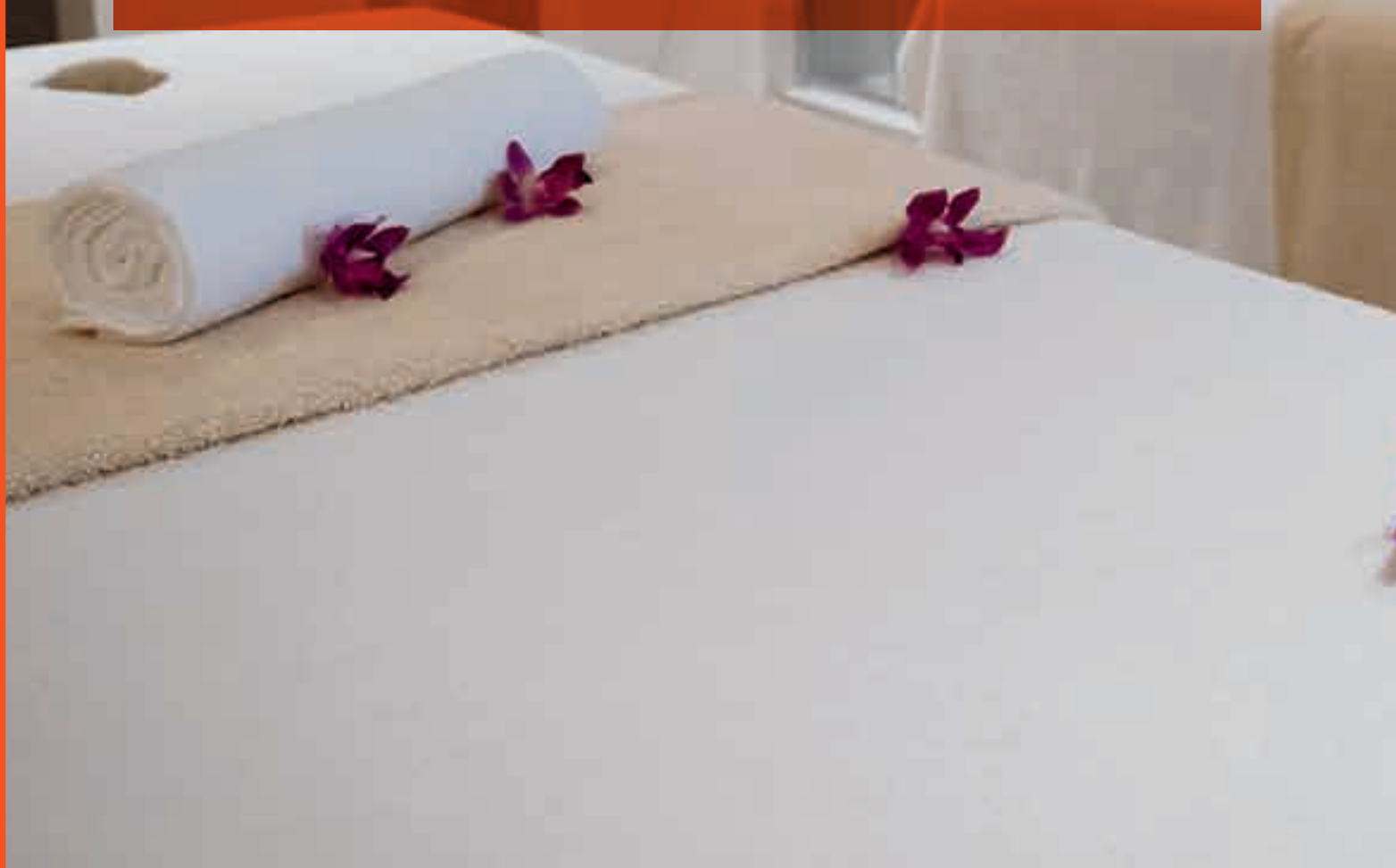





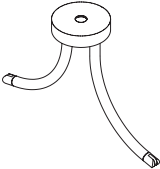
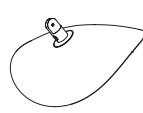

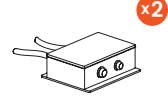
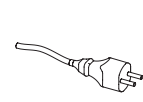
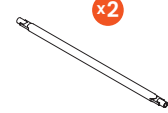
ATTACCO DOPPIO A SOFFITTO

ceiling double mounting / doppelte deckenbefestigung /
plafonier double / soporte doble a techo



CONFIGURA LA TUA HOTDOOR

Customize your Hotdoor / Konfigurieren Sie Ihre Hotdoor / Configure ton Hotdoor / Configura tu Hotdoor

MODELLO Model / Modell Modèle / Modelo	COLORE CORPO Body color / Farbe Körper Couleur corp / Color cuerpo	COLORE COVER Cover color / Farbe Bedeckung / Couleur couverture / Color cubierta	DIMMER Dimmer / Dimmer Gradateur / Regulador	SPINA Plug / Stecker / Prise de courant / Enchufe	POTENZA Power / Leistung Puissance / Potencia
					
HBA21	01 BLACK 	01 BLACK 	0 NO DIMMER	0 UE	05 1500 W* 110 V (us)
	02 WHITE 	02 WHITE 	1 DIMMER BASIC* 235 V (UE-UK-CH-AUS)	1 UK	15 1500 W* 235 V (UE-UK-CH-AUS)
	06 BEIGE* 	03 SILVER* 	2 DIMMER SMART* 110 V (us)	2 US	20 2000 W 235 V (UE-UK-CH-AUS)
		04 BRASS* 	3 DIMMER SMART* 235 V (UE-UK-CH)	3 CH	
		05 GREY* 		4 AUS**	
		06 BEIGE 			

PREZZO

price / prix / preis / precio

Da aggiungere al prezzo base / To add to standard price / Zum Basispreis hinzufügen / Ajouter au prix de base / Añadir al precio base*
solo con NO DIMMER o DIMMER BASIC / only with NO DIMMER or DIMMER BASIC / Nur mit KEIN DIMMER oder DIMMER BASIC / seul avec NO DIMMER ou DIMMER BASIC / sólo con NO DIMMER o DIMMER BASIC**

DIMENSIONI [mm]

dimensions / abmessungen / dimension / dimensiones

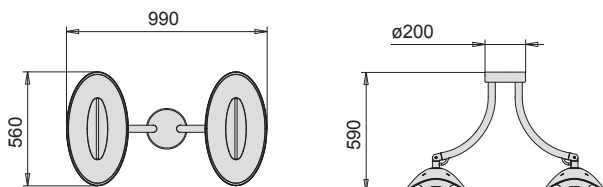

IMBALLO [mm]

packaging / verpackung / emballage / embalaje

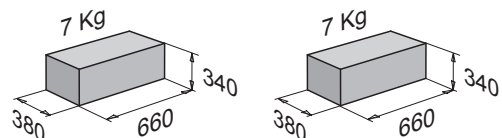











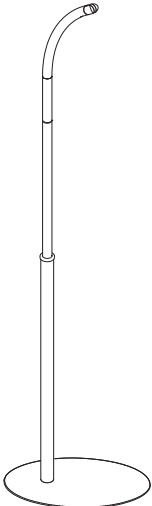

hotdoor

PIANTANA SINGOLA ARCO CORTO

floor single stem lamp / einzelfußbodenständer /
lampadaire single / lámpara de pie individual

CONFIGURA LA TUA HOTDOOR

Customize your Hotdoor / Konfigurieren Sie Ihre Hotdoor / Configure ton Hotdoor / Configura tu Hotdoor

MODELLO Model / Modell Modèle / Modelo	COLORE CORPO Body color / Farbe Körper Couleur corp / Color cuerpo	COLORE COVER Cover color / Farbe Bedeckung / Couleur couverture / Color cubierta	DIMMER Dimmer / Dimmer Gradateur / Regulador	SPINA Plug / Stecker / Prise de courant / Enchufe	POTENZA Power / Leistung Puissance / Potencia
 HCA01	01 BLACK 	01 BLACK 	0 NO DIMMER	0 UE	05 1500 W* 110 V (us)
	02 WHITE 	02 WHITE 	1 DIMMER BASIC* 235 V (UE-UK-CH-AUS)	1 UK	15 1500 W* 235 V (UE-UK-CH-AUS)
	06 BEIGE* 	03 SILVER* 	2 DIMMER SMART* 110 V (us)	2 US	20 2000 W 235 V (UE-UK-CH-AUS)
		04 BRASS* 	3 DIMMER SMART* 235 V (UE-UK-CH)	3 CH	
		05 GREY* 		4 AUS**	
		06 BEIGE 			

PREZZO

price / prix / preis / precio

Da aggiungere al prezzo base / To add to standard price / Zum Basispreis hinzufügen / Ajouter au prix de base / Añadir al precio base*
solo con NO DIMMER o DIMMER BASIC / only with NO DIMMER or DIMMER BASIC / Nur mit KEIN DIMMER oder DIMMER BASIC / seul avec NO DIMMER ou DIMMER BASIC / sólo con NO DIMMER o DIMMER BASIC**

DIMENSIONI [mm]

dimensions / abmessungen / dimension / dimensiones

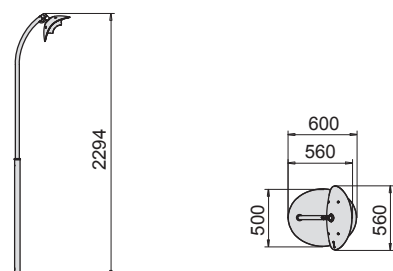

IMBALLO [mm]

packaging / verpackung / emballage / embalaje

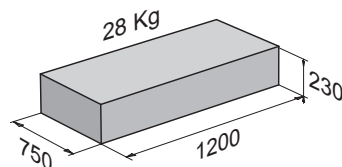

hotdoor









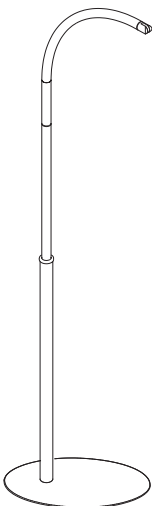

PIANTANA SINGOLA ARCO MEDIO

floor single stem lamp / einzelfußbodenständer /
lampadaire single / lámpara de pie individual



CONFIGURA LA TUA HOTDOOR

Customize your Hotdoor / Konfigurieren Sie Ihre Hotdoor / Configure ton Hotdoor / Configura tu Hotdoor

MODELLO Model / Modell Modèle / Modelo	COLORE CORPO Body color / Farbe Körper Couleur corp / Color cuerpo	COLORE COVER Cover color / Farbe Bedeckung / Couleur couverture / Color cubierta	DIMMER Dimmer / Dimmer Gradateur / Regulador	SPINA Plug / Stecker / Prise de courant / Enchufe	POTENZA Power / Leistung Puissance / Potencia
 <p>HCA02</p>	01 BLACK 	01 BLACK 	0 NO DIMMER	0 UE	05 1500 W* 110 V (us)
	02 WHITE 	02 WHITE 	1 DIMMER BASIC* 235 V (UE-UK-CH-AUS)	1 UK	15 1500 W* 235 V (UE-UK-CH-AUS)
	06 BEIGE* 	03 SILVER* 	2 DIMMER SMART* 110 V (us)	2 US	20 2000 W 235 V (UE-UK-CH-AUS)
		04 BRASS* 	3 DIMMER SMART* 235 V (UE-UK-CH)	3 CH	
		05 GREY* 		4 AUS**	
		06 BEIGE 			

PREZZO

price / prix / preis / precio

Da aggiungere al prezzo base / To add to standard price / Zum Basispreis hinzufügen / Ajouter au prix de base / Añadir al precio base*
solo con NO DIMMER o DIMMER BASIC / only with NO DIMMER or DIMMER BASIC / Nur mit KEIN DIMMER oder DIMMER BASIC / seul avec NO DIMMER ou DIMMER BASIC / sólo con NO DIMMER o DIMMER BASIC**

DIMENSIONI [mm]

dimensions / abmessungen / dimension / dimensiones

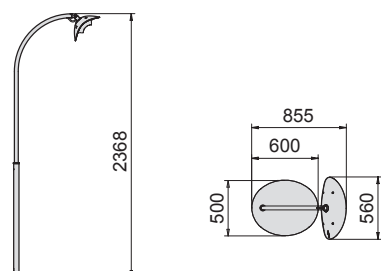

IMBALLO [mm]

packaging / verpackung / emballage / embalaje

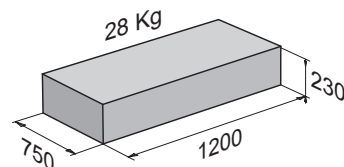

hotdoor









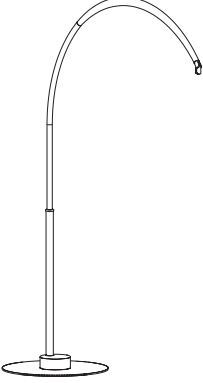

PIANTANA SINGOLA DA TAVOLO

floor single stem table lamp / einzelfußbodenständer für tisch /
lampadaire single pour le table / lámpara de pie para la mesa



CONFIGURA LA TUA HOTDOOR

Customize your Hotdoor / Konfigurieren Sie Ihre Hotdoor / Configure ton Hotdoor / Configura tu Hotdoor

MODELLO Model / Modell Modèle / Modelo	COLORE CORPO Body color / Farbe Körper Couleur corp / Color cuerpo	COLORE COVER Cover color / Farbe Bedeckung / Couleur couverture / Color cubierta	DIMMER Dimmer / Dimmer Gradateur / Regulador	SPINA Plug / Stecker / Prise de courant / Enchufe	POTENZA Power / Leistung Puissance / Potencia
 HCB01	01 BLACK 	01 BLACK 	0 NO DIMMER	0 UE	05 1500 W* 110 V (us)
	02 WHITE 	02 WHITE 	1 DIMMER BASIC* 235 V (UE-UK-CH-AUS)	1 UK	15 1500 W* 235 V (UE-UK-CH-AUS)
	06 BEIGE* 	03 SILVER* 	2 DIMMER SMART* 110 V (us)	2 US	20 2000 W 235 V (UE-UK-CH-AUS)
		04 BRASS* 	3 DIMMER SMART* 235 V (UE-UK-CH)	3 CH	
		05 GREY* 		4 AUS**	
		06 BEIGE 			

PREZZO

price / prix / preis / precio

Da aggiungere al prezzo base / To add to standard price / Zum Basispreis hinzufügen / Ajouter au prix de base / Añadir al precio base*
solo con NO DIMMER o DIMMER BASIC / only with NO DIMMER or DIMMER BASIC / Nur mit KEIN DIMMER oder DIMMER BASIC / seul avec NO DIMMER ou DIMMER BASIC / sólo con NO DIMMER o DIMMER BASIC**

DIMENSIONI [mm]

dimensions / abmessungen / dimension / dimensiones

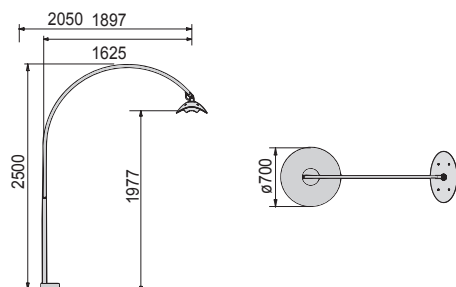

IMBALLO [mm]

packaging / verpackung / emballage / embalaje

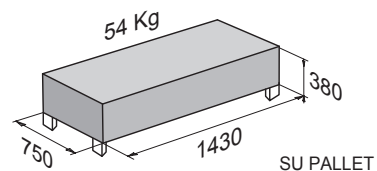

Per la creazione del codice, vedi l'esempio a pagina 11. - To create your code, see example at page 11. - Zur Erstellung des codes siehe Beispiel auf Seite 11.
Pour la création du code, voir l'exemple à la page 11. - Para la creación del código, vea el ejemplo en la página 11.

hotdoor









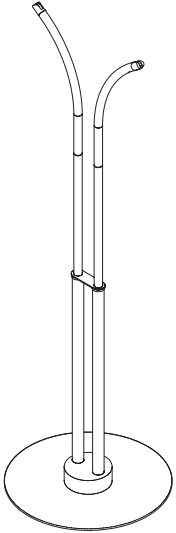

PIANTANA DOPPIA ARCO CORTO

floor double stem lamp / doppelfußbodenständer
lampadaire double / lámpara de pie doble



CONFIGURA LA TUA HOTDOOR

Customize your Hotdoor / Konfigurieren Sie Ihre Hotdoor / Configure ton Hotdoor / Configura tu Hotdoor

MODELLO Model / Modell Modèle / Modelo	COLORE CORPO Body color / Farbe Körper Couleur corp / Color cuerpo	COLORE COVER Cover color / Farbe Bedeckung / Couleur couverture / Color cubierta	DIMMER Dimmer / Dimmer Gradateur / Regulador	SPINA Plug / Stecker / Prise de courant / Enchufe	POTENZA Power / Leistung Puissance / Potencia
 HCA21	01 BLACK 	01 BLACK 	0 NO DIMMER	0 UE	05 1500 W* 110 V (us)
	02 WHITE 	02 WHITE 	1 DIMMER BASIC* 235 V (UE-UK-CH-AUS)	1 UK	15 1500 W* 235 V (UE-UK-CH-AUS)
	06 BEIGE* 	03 SILVER* 	2 DIMMER SMART* 110 V (us)	2 US	20 2000 W 235 V (UE-UK-CH-AUS)
		04 BRASS* 	3 DIMMER SMART* 235 V (UE-UK-CH)	3 CH	
		05 GREY* 		4 AUS**	
		06 BEIGE 			

PREZZO

price / prix / preis / precio

Da aggiungere al prezzo base / To add to standard price / Zum Basispreis hinzufügen / Ajouter au prix de base / Añadir al precio base*
solo con NO DIMMER o DIMMER BASIC / only with NO DIMMER or DIMMER BASIC / Nur mit KEIN DIMMER oder DIMMER BASIC / seul avec NO DIMMER ou DIMMER BASIC / sólo con NO DIMMER o DIMMER BASIC**

DIMENSIONI [mm]

dimensions / abmessungen / dimension / dimensiones

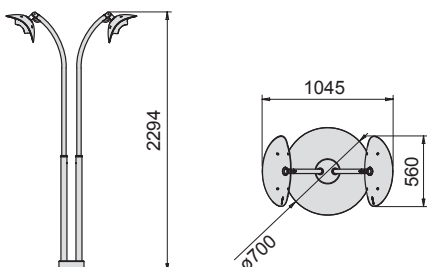

IMBALLO [mm]

packaging / verpackung / emballage / embalaje

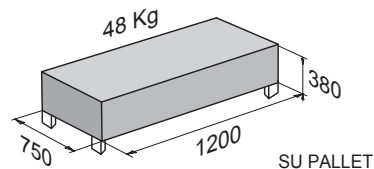

hotdoor









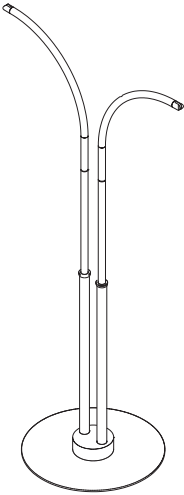
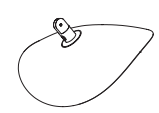
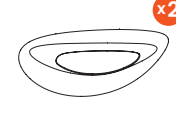
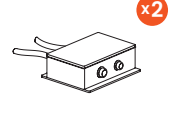
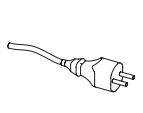
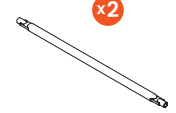

PIANTANA DOPPIA ARCO MEDIO

floor double stem lamp / doppelfußbodenständer
lampadaire double / lámpara de pie doble



CONFIGURA LA TUA HOTDOOR

Customize your Hotdoor / Konfigurieren Sie Ihre Hotdoor / Configure ton Hotdoor / Configura tu Hotdoor

MODELLO Model / Modell Modèle / Modelo	COLORE CORPO Body color / Farbe Körper Couleur corp / Color cuerpo	COLORE COVER Cover color / Farbe Bedeckung / Couleur couverture / Color cubierta	DIMMER Dimmer / Dimmer Gradateur / Regulador	SPINA Plug / Stecker / Prise de courant / Enchufe	POTENZA Power / Leistung Puissance / Potencia
 <p>HCA22</p>					
	01 BLACK 	01 BLACK 	0 NO DIMMER	0 UE	05 1500 W* 110 V (us)
	02 WHITE 	02 WHITE 	1 DIMMER BASIC* 235 V (UE-UK-CH-AUS)	1 UK	15 1500 W* 235 V (UE-UK-CH-AUS)
	06 BEIGE* 	03 SILVER* 	2 DIMMER SMART* 110 V (us)	2 US	20 2000 W 235 V (UE-UK-CH-AUS)
		04 BRASS* 	3 DIMMER SMART* 235 V (UE-UK-CH)	3 CH	
		05 GREY* 		4 AUS**	
		06 BEIGE 			

PREZZO

price / prix / preis / precio

Da aggiungere al prezzo base / To add to standard price / Zum Basispreis hinzufügen / Ajouter au prix de base / Añadir al precio base*
solo con NO DIMMER o DIMMER BASIC / only with NO DIMMER or DIMMER BASIC / Nur mit KEIN DIMMER oder DIMMER BASIC / seul avec NO DIMMER ou DIMMER BASIC / sólo con NO DIMMER o DIMMER BASIC**

DIMENSIONI [mm]

dimensions / abmessungen / dimension / dimensiones

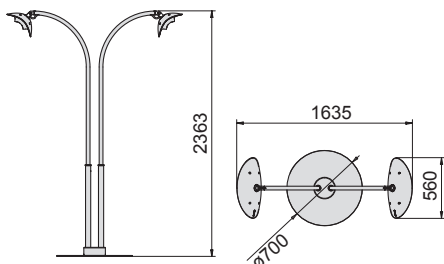

IMBALLO [mm]

packaging / verpackung / emballage / embalaje

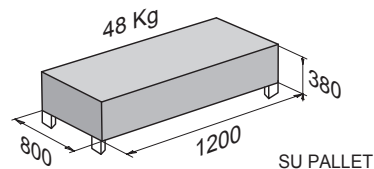

hotdoor

COMPOSIZIONE STANDARD DEI PRODOTTI

standard versions of the products / standard produktvariationen
compositions standards des produits / composición estandar de los productos



COMPOSIZIONE STANDARD DEI PRODOTTI

standard versions of the products / standard produktvariationen /
compositions standards des produits / composición estandar de los productos

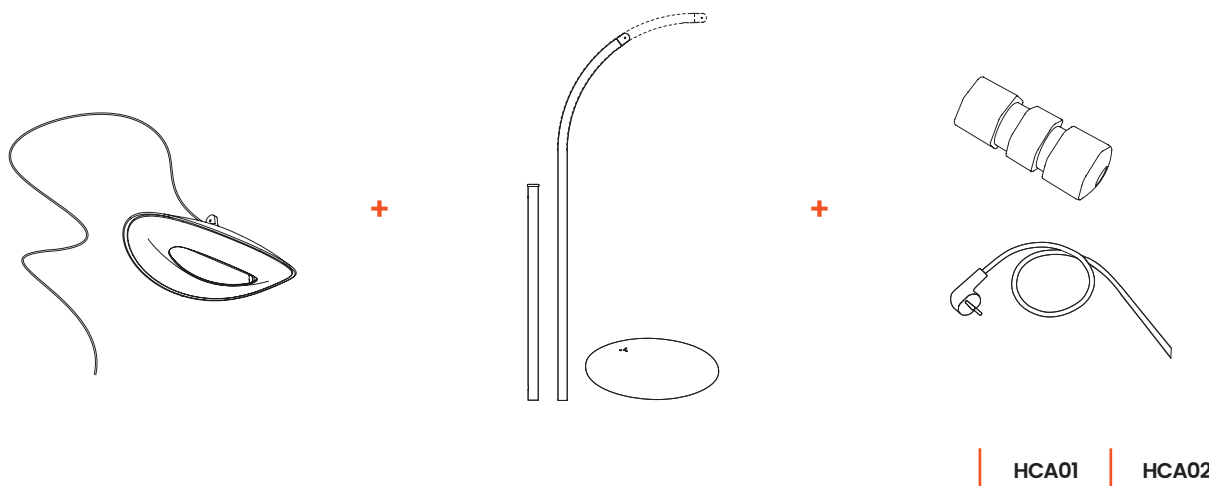
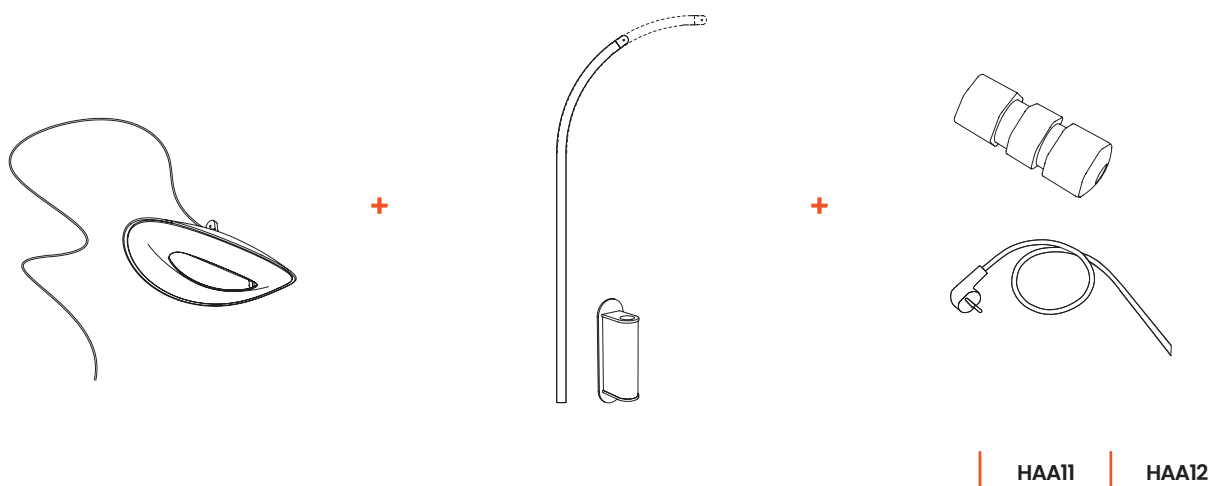
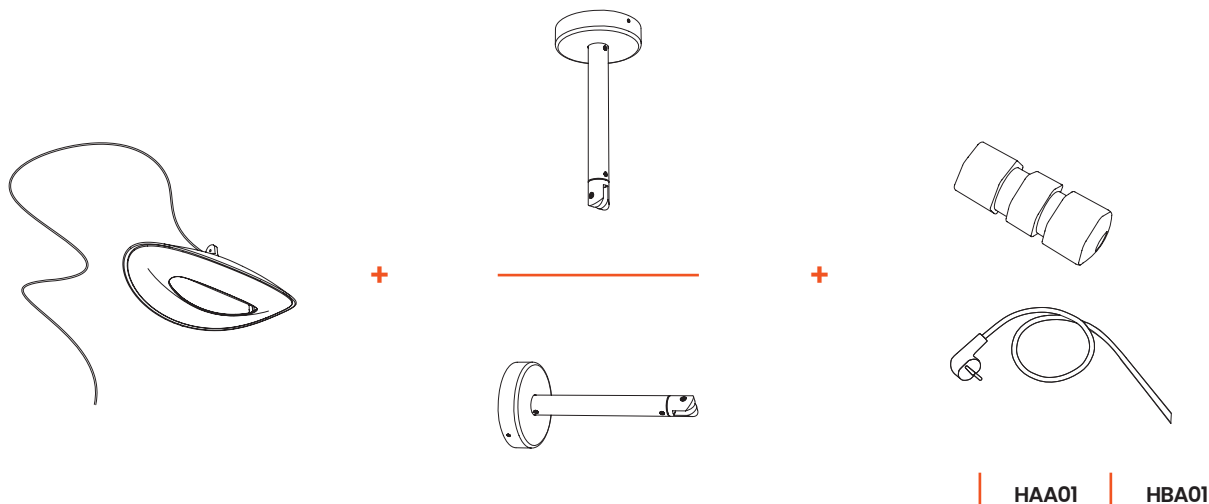

COMPOSIZIONE STANDARD DEI PRODOTTI

standard versions of the products / standard produktvariationen /
compositions standards des produits / composición estandar de los productos

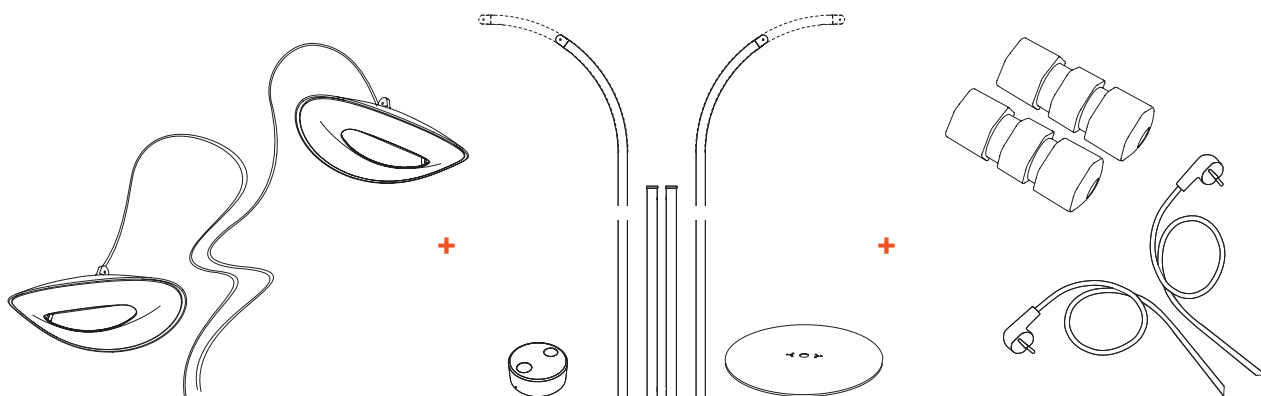

HCA21

HCA22

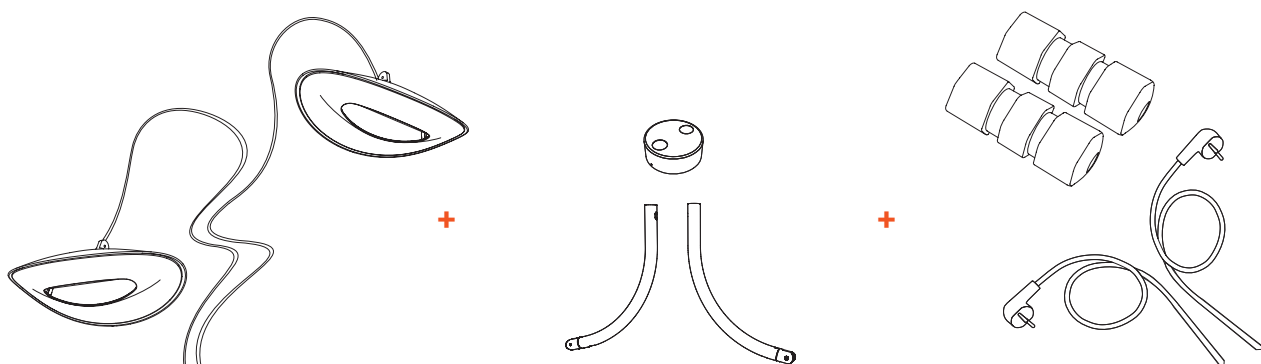

HBA21

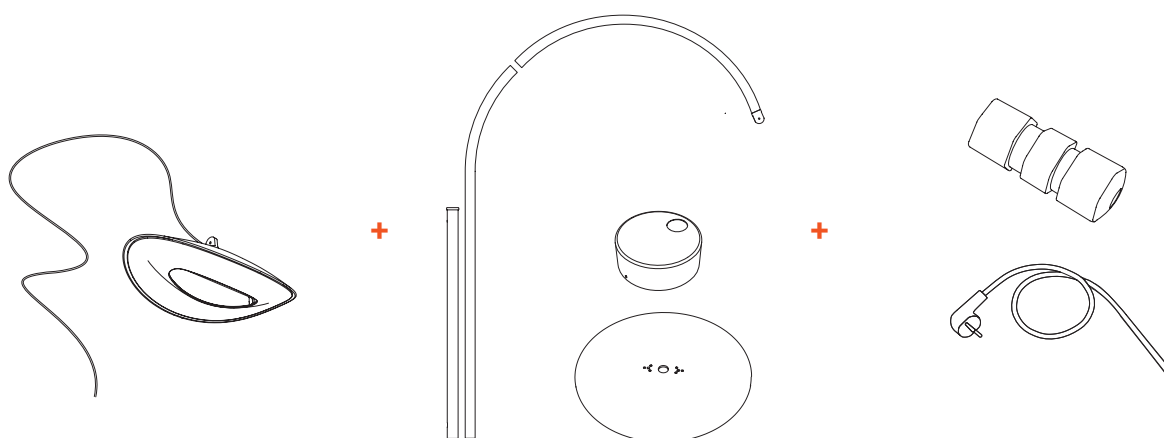

HCB01



phormalab

INFRAREDS

MADE IN ITALY



phormalab

INFRAREDS

MADE IN ITALY





aura

Uno sguardo al futuro

aura

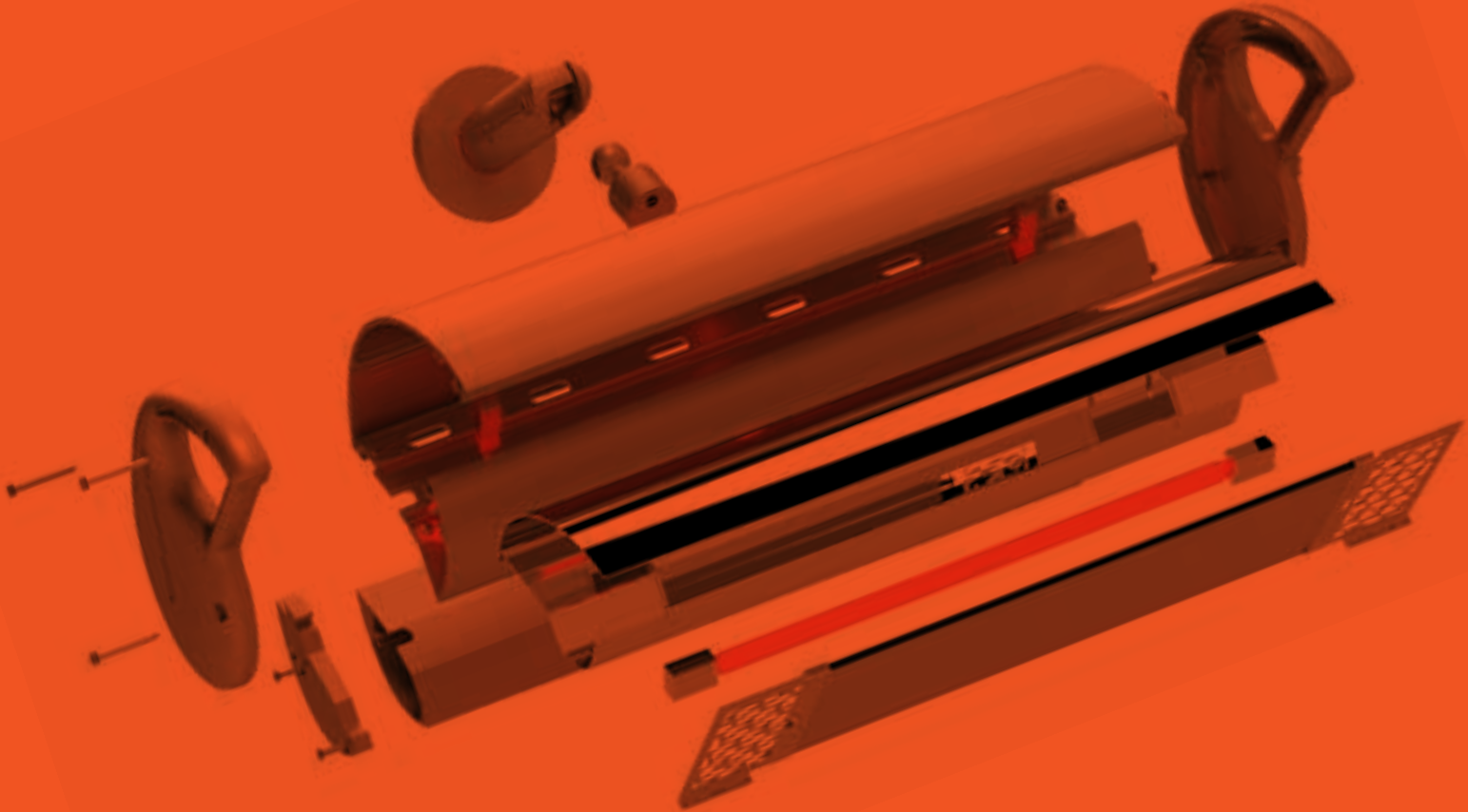

DESIGN E QUALITÀ MADE IN ITALY

design and quality made in Italy / design und qualität made in Italy /
design et qualite made in Italy / diseño y calidad made in Italy

aura DESIGN BY STEFANO PASOTTI

IT

DESIGN: Disegnato e prodotto in Italia
MATERIALI: Corpo e supporti in alluminio
DURATA DELLA LAMPADINA: 5.000 ore circa
GRADO DI PROTEZIONE: IP44 (la lampada è utilizzabile anche in spazi esterni e resiste agli spruzzi d'acqua)
POTENZE DISPONIBILI: 2000 W
ALIMENTAZIONE: 230 V – 50/60 Hz (disponibile anche 110 V)
ENERGIA ASSORBITA: Oltre il 90% dell'energia assorbita viene emessa sottoforma di raggi infrarossi
ORIENTAMENTO: Fascio scaldante
GAMMA: Con attacco a parete o a soffitto
COLORI CORPO LAMPADA E ACCESSORI: Nero o Argento



EN

DESIGN: Designed and manufactured in Italy
MATERIALS: Heater body and accessories in aluminum
BULB LIFE: about 5.000 hours
PROTECTION LEVEL: IP44 (the lamp can be used outdoors and assures perfect impermeability against water sprinkling)
AVAILABLE POWERS: 2000 W
POWER SUPPLY: 230 V – 50/60 Hz (available 110 V)
ABSORBED ENERGY: More than 90% of the absorbed energy is radiated as infrared emission
ORIENTATION: Adjustable heating beam
RANGE: Wall mounting, ceiling mounting
COLORS HEATER BODY AND ACCESSORIES: Black or silver



DE

DESIGN: Italienisches Design und hergestellt in Italien
MATERIALIEN: Strahlerkörper und Zubehöre aus aluminium
DAUER DES HEIZELEMENTS: 5.000 Stunden ungefähr
SCHUTZART: IP44 (Strahler nutzbar in Außerräumen und Spritwasser- und Regenfest)
VERFÜGBARE LEISTUNGEN: 2000 W
STROMZUFUHR: 230 V – 50/60 Hz (verfügbar 110 V)
ABSORBIERTEN ENERGIE: Über 90% der absorbierten Energie strahlt als Infra-rotstrahlung aus
ORIENTIERUNG: Einstellbarer Heizstrahl
VERFÜGBARE LÖSUNGEN: Wandhalterung, Deckenhalterung
VERFÜGBARE FARBEN KÖRPER UND BEFESTIGUNGSELEMENTE: Schwarz oder Silber



FR

DESIGN: Design et production italienne
MATÉRIELS: Corps de la lampe et accessoires en aluminium
DURÉE DE L'AMPOULE : 5.000 heures a peu près
PROTECTION: IP44 (la lampe peut être utilisée à l'extérieur et est imperméable aux jets d'eau et à la pluie)
PUISSANCES DISPONIBLES: 2000 W
ALIMENTATION: 230 V – 50/60 Hz (disponible aussi 110 V)
ÉNERGIE ABSORBÉE: Plus que 90% de l'énergie absorbée vient réémise comme radiation infrarouge
ORIENTATION: Lampe orientable
SOLUTIONS: Appliques, plafonniers
COULEURS DISPONIBLES CORPS DE LA LAMPE ET ACCESSOIRES: Blanc ou argent



ES

DESIGN: Diseñada y producida en Italia
MATERIALES: Cuerpo y accesorios de aluminio
DURACIÓN DE LA BOMBILLA: 5.000 horas aproximadamente
GRADO DE PROTECCIÓN: IP44 (la lámpara puede ser utilizada al exterior, resistente a las salpicaduras de agua y a la lluvia)
POTENCIAS DISPONIBLES: 2000 W
ALIMENTACIÓN: 230 V – 50/60 Hz (110 V también disponible)
ENERGÍA ABSORBIDA: Más del 90% de la energía absorbida es emitida en forma de radiación infrarroja
ORIENTACIÓN: Haz de rayos infrarrojos regulable
GAMA: Soporte a pared o techo, de pie, individuales y dobles
COLORS CUERPO, DE LA LÁMPARA Y ACCESORIOS: Negro o plata



aura



COMPOSIZIONI

versions / kompositionen /
compositions / composiciones

PARETE

wall / wand / murale / pared

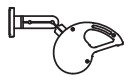

P 46 – 49

SOFFITTO

ceiling / decke / plafonnier / techo

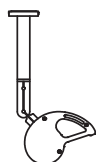

P 46 – 49

OMBRELLONE SINGOLO

single umbrella / Einzelsommenschirm /
parasol simple / sombrilla s ngula

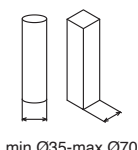
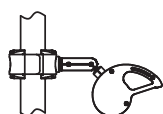

min.Ø35-max.Ø70



cinturino realizzato
in collaborazione con
CHIARUGI
BANDIERE DI FIRENZE
1888

P 50 – 51
P 54 – 55

OMBRELLONE DOPPIO

duble umbrella / Doppelsommenschirm /
parasol double / sombrilla doble

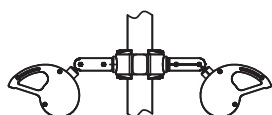

min.Ø35-max.Ø70



cinturino realizzato
in collaborazione con
CHIARUGI
BANDIERE DI FIRENZE
1888

P 52 – 53
P 56 – 57



aura

COLORI

colors / farben /
couleurs / colores

AURA BASIC



■ **NERO**
black / schwarz / noir / negro

AURA SMART



■ **NERO**
black / schwarz / noir / negro

■ **ARGENTO**
silver / Silber / argent / plata

aura

VERSIONI

versions / kompositionen /
compositions / composiciones



AURA BASIC



MONTAGGIO: PARETE-SOFFITTO

Mounting: wall-ceiling / Befestigung: Wand-Decke

Montage: paroi-plafond / Montaje: pared/techo

POTENZA: **2000W**

Power / Leistung / Puissance / Potencia

COLORE: NERO

Colour: black / Farbe: schwarz

Couleur: noir / Color: negro

AURA SMART



TELECOMANDO

Remote control / Fernbedienung

Télécommande / Telemando

ios/Android App

TIMER

Timer / Zeitgeber / Minuterie / Temporizador

DIMMER

Dimmer / Dimmer / Gradateur / Regulador

MONTAGGIO: PARETE-SOFFITTO

Mounting: wall-ceiling / Befestigung: Wand-Decke

Montage: paroi-plafond / Montaje: pared/techo

POTENZA: **2000W**

Power / Leistung / Puissance / Potencia

COLORE: NERO - ARGENTO

Colours: black-silver / Farbe: schwarz-Silber

Couleurs: noir-argent / Colores: negro-plata

WATER PROOF
IP44



SMARTPHONE [IOS/ANDROID]
REMOTE CONTROL





aura



AURA BASIC ATTACCO PARETE-SOFFITTO

wall-ceiling / wand-decke
murale-plafonnier / pared-techo

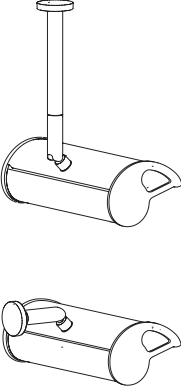

CONFIGURA LA TUA AURA BASIC PARETE-SOFFITTO

Customize your Aura / Konfigurieren Sie Ihre Aura / Configure ton Aura / Configura tu Aura

MODELLO Model / Modell Modèle / Modelo	COLORE CORPO Body color / Farbe Körper Couleur corp / Color cuerpo			SPINA Plug / Stecker / Prise de courant / Enchufe	POTENZA Power / Leistung Puissance / Potencia
	<p>01 BLACK</p> 	<p>00</p>	<p>0</p>	<p>0 UE</p> <hr/> <p>1 UK</p> <hr/> <p>2 US</p> <hr/> <p>3 CH</p> <hr/> <p>4 AUS</p>	<p>05 1500 W* 110 V (us)</p> <hr/> <p>15 1500 W* 235 V (UE-UK-CH-AUS)</p> <hr/> <p>20 2000 W 235 V (UE-UK-CH-AUS)</p>
<p>AAA01</p>	<p>01</p>	<p>00</p>	<p>0</p>	<p>_____</p>	<p>_____</p>

PREZZO

price / prix / preis / precio

Da aggiungere al prezzo base / To add to standard price / Zum Basispreis hinzufügen / Ajouter au prix de base / Añadir al precio base*

DIMENSIONI [mm]

dimensions / abmessungen / dimension / dimensiones

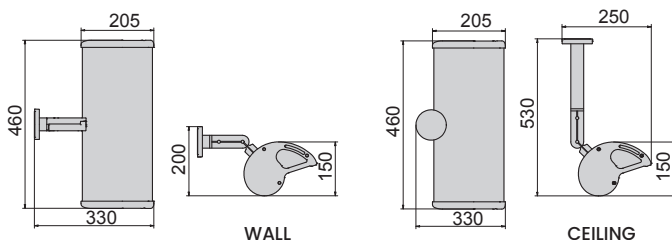

IMBALLO [mm]

packaging / verpackung / emballage / embalaje

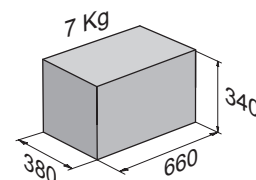

Per la creazione del codice, vedi l'esempio a pagina 11. - To create your code, see example at page 11. - Zur Erstellung des codes siehe Beispiel auf Seite 11. - Pour la création du code, voir l'exemple à la page 11. - Para la creación del código, vea el ejemplo en la página 11.



aura





**AURA SMART
ATTACCO PARETE-SOFFITTO**

wall-ceiling / wand-decke
murale-plafonnier / pared-techo

CONFIGURA LA TUA AURA SMART PARETE-SOFFITTO

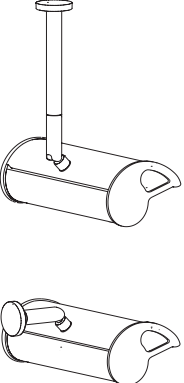
Customize your Aura / Konfigurieren Sie Ihre Aura / Configure ton Aura / Configura tu Aura

MODELLO Model / Modell Modèle / Modelo	COLORE CORPO Body color / Farbe Körper Couleur corp / Color cuerpo		DIMMER Dimmer / Dimmer Gradateur / Regulator	SPINA Plug / Stecker / Prise de courant / Enchufe	POTENZA Power / Leistung Puissance / Potencia
	01 BLACK 	00	1 DIMMER 235 V (UE-UK-CH-AUS)	0 UE 1 UK 3 CH 4 AUS	15 1500 W* 235 V (UE-UK-CH-AUS)
	03 SILVER 				20 2000 W 235 V (UE-UK-CH-AUS)
AAA01	___	00	1	___	___

PREZZO

price / prix / preis / precio

Da aggiungere al prezzo base / To add to standard price / Zum Basispreis hinzufügen / Ajouter au prix de base / Añadir al precio base*

DIMENSIONI [mm]

dimensions / abmessungen / dimension / dimensiones

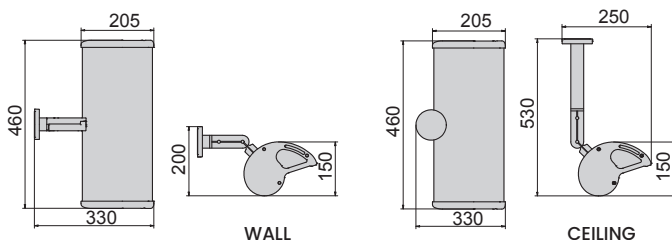

IMBALLO [mm]

packaging / verpackung / emballage / embalaje

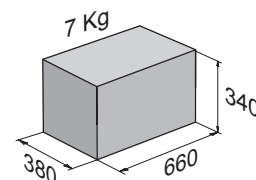



aura

AURA BASIC OMBRELLONE SINGOLO

single umbrella / Einzelsonnenschirm
parasol simple / sombrilla s ngula

CONFIGURA LA TUA AURA BASIC OMBELLONE SINGOLO

Customize your Aura / Konfigurieren Sie Ihre Aura / Configure ton Aura / Configura tu Aura

MODELLO Model / Modell Modèle / Modelo	COLORE CORPO Body color / Farbe Körper Couleur corp / Color cuerpo			SPINA Plug / Stecker / Prise de courant / Enchufe	POTENZA Power / Leistung Puissance / Potencia
	01 BLACK 			0 UE	05 1500 W* 110 V (us)
				1 UK	15 1500 W* 235 V (UE-UK-CH-AUS)
				2 US	20 2000 W 235 V (UE-UK-CH-AUS)
				3 CH	
				4 AUS	
ADA01	01	00	0	_____	_____

PREZZO

price / prix / preis / precio

Da aggiungere al prezzo base / To add to standard price / Zum Basispreis hinzufügen / Ajouter au prix de base / Añadir al precio base*

DIMENSIONI [mm]

dimensions / abmessungen / dimension / dimensiones

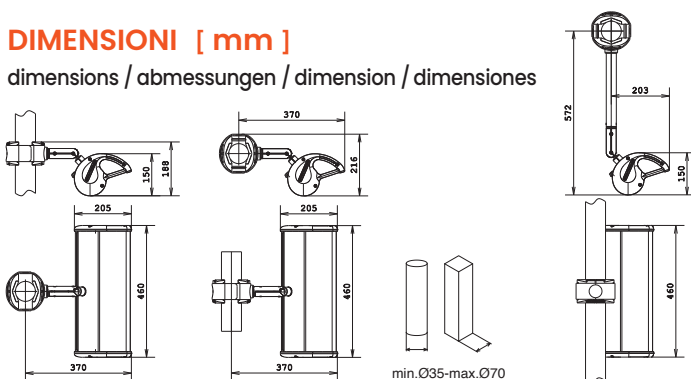

IMBALLO [mm]

packaging / verpackung / emballage / embalaje

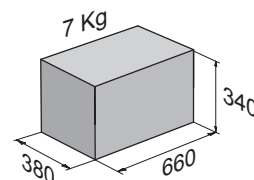

Per la creazione del codice, vedi l'esempio a pagina 11. - To create your code, see example at page 11. - Zur Erstellung des codes siehe Beispiel auf Seite 11. - Pour la création du code, voir l'exemple à la page 11. - Para la creación del código, vea el ejemplo en la página 11.





aura

AURA BASIC OMBRELLONE DOPPIO

duble umbrella / Doppelsonnenschirm
parasol double / sombrilla doble

CONFIGURA LA TUA AURA BASIC OMBELLONE DOPPIO

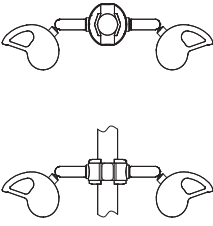
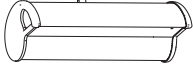
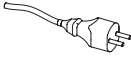
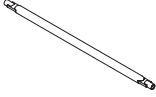
Customize your Aura / Konfigurieren Sie Ihre Aura / Configure ton Aura / Configura tu Aura

MODELLO Model / Modell Modèle / Modelo	COLORE CORPO Body color / Farbe Körper Couleur corp / Color cuerpo			SPINA Plug / Stecker / Prise de courant / Enchufe	POTENZA Power / Leistung Puissance / Potencia
					
	01 BLACK 			0 UE	05 1500 W* 110 V (us)
				1 UK	15 1500 W* 235 V (UE-UK-CH-AUS)
				2 US	20 2000 W 235 V (UE-UK-CH-AUS)
				3 CH	
				4 AUS	
ADA21	01	00	0	_____	_____

PREZZO

price / prix / preis / precio

Da aggiungere al prezzo base / To add to standard price / Zum Basispreis hinzufügen / Ajouter au prix de base / Añadir al precio base*

DIMENSIONI [mm]

dimensions / abmessungen / dimension / dimensiones

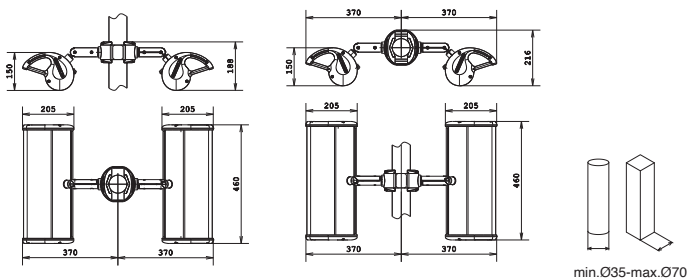

IMBALLO [mm]

packaging / verpackung / emballage / embalaje

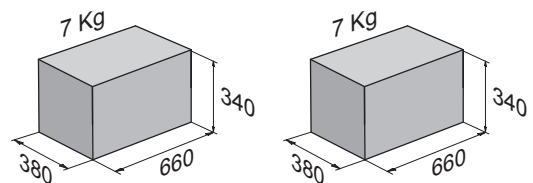

Per la creazione del codice, vedi l'esempio a pagina 11. - To create your code, see example at page 11. - Zur Erstellung des codes siehe Beispiel auf Seite 11.
Pour la création du code, voir l'exemple à la page 11. - Para la creación del código, vea el ejemplo en la página 11.

A black patio umbrella is the central focus, with a black heater attached to its frame. The heater has a glowing orange light inside. The umbrella is on a balcony with a metal railing. In the background, there are buildings with tiled roofs and a clear sky. A tufted grey sofa with white and black cushions is visible in the lower right. A potted plant with pink flowers is in the lower left.





aura

AURA SMART OMBRELLONE SINGOLO

single umbrella / Einzelsonnenschirm
parasol simple / sombrilla s ngula

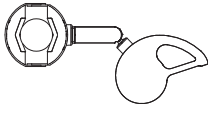
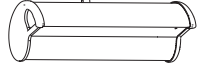
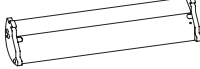
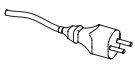
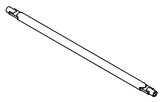
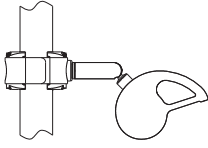
CONFIGURA LA TUA AURA SMART SINGOLO OMBRELLONE

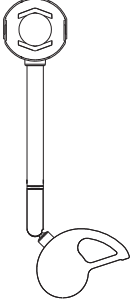
Customize your Aura / Konfigurieren Sie Ihre Aura / Configure ton Aura / Configura tu Aura

MODELLO Model / Modell Modèle / Modelo	COLORE CORPO Body color / Farbe Körper Couleur corp / Color cuerpo	DIMMER Dimmer / Dimmer Gradateur / Regulador	SPINA Plug / Stecker / Prise de courant / Enchufe	POTENZA Power / Leistung Puissance / Potencia
				
	01 BLACK 		0 UE	15 1500 W* 235 V (UE-UK-CH-AUS)
	03 SILVER 	1 DIMMER 235 V (UE-UK-CH-AUS)	1 UK	20 2000 W 235 V (UE-UK-CH-AUS)
			3 CH	
			4 AUS	
ADA01	___	00	___	___

PREZZO

price / prix / preis / precio

Da aggiungere al prezzo base / To add to standard price / Zum Basispreis hinzufügen / Ajouter au prix de base / Añadir al precio base*

DIMENSIONI [mm]

dimensions / abmessungen / dimension / dimensiones

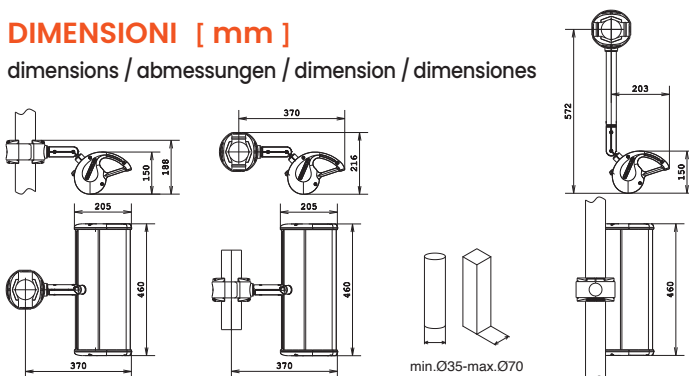

IMBALLO [mm]

packaging / verpackung / emballage / embalaje

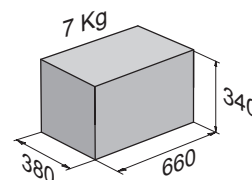

Per la creazione del codice, vedi l'esempio a pagina 11. - To create your code, see example at page 11. - Zur Erstellung des Codes siehe Beispiel auf Seite 11. - Pour la création du code, voir l'exemple à la page 11. - Para la creación del código, vea el ejemplo en la página 11.

aura







AURA SMART OMBRELLONE DOPPIO

duble umbrella / Doppelsonnenschirm
parasol double / sombrilla doble

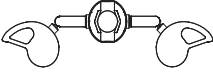
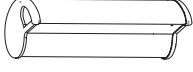
CONFIGURA LA TUA AURA SMART DOPPIO OMBRELLONE

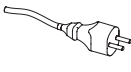
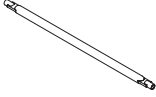
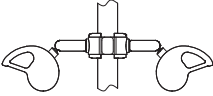
Customize your Aura / Konfigurieren Sie Ihre Aura / Configure ton Aura / Configura tu Aura

MODELLO Model / Modell Modèle / Modelo	COLORE CORPO Body color / Farbe Körper Couleur corp / Color cuerpo		DIMMER Dimmer / Dimmer Gradateur / Regulador	SPINA Plug / Stecker / Prise de courant / Enchufe	POTENZA Power / Leistung Puissance / Potencia
					
	01 BLACK 			0 UE	15 1500 W* 235 V (UE-UK-CH-AUS)
	03 SILVER 		1 DIMMER 235 V (UE-UK-CH-AUS)	1 UK	20 2000 W 235 V (UE-UK-CH-AUS)
				3 CH	
				4 AUS	
ADA21	___	00	1	___	___

PREZZO

price / prix / preis / precio

Da aggiungere al prezzo base / To add to standard price / Zum Basispreis hinzufügen / Ajouter au prix de base / Añadir al precio base*

DIMENSIONI [mm]

dimensions / abmessungen / dimension / dimensiones

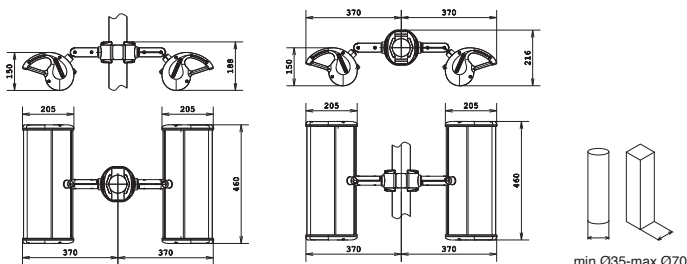

IMBALLO [mm]

packaging / verpackung / emballage / embalaje

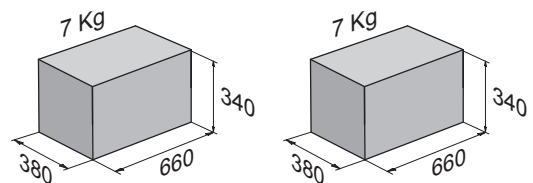

Per la creazione del codice, vedi l'esempio a pagina 11. - To create your code, see example at page 11. - Zur Erstellung des codes siehe Beispiel auf Seite 11. - Pour la création du code, voir l'exemple à la page 11. - Para la creación del código, vea el ejemplo en la página 11.

phormalab
INFRAREDS



ACCESSORI E RICAMBI

accessories and spare parts / zubehöre und ersatzteile
accessoires et pièces de rechange / accesorios y piezas de recambio



ACCESSORI E RICAMBI

accessories and spare parts / zubehör und ersatzteile / accessoires et pièces de rechange / accesorios y repuestos

DIMMER BASIC

dimmer / Dimmer / Gradateur / Regulador

Info tecniche p. 10
 Technical information p. 10
 Technische Informationen p. 10
 Informations techniques p. 10
 Informaciones técnicas p.10



DIM01

TELECOMANDO

remote control switch / Fernbedienung
 télécommande / mando a distancia



TELO1

TELECOMANDO A PARETE

wall remote control switch / Wand-Fernbedienung
 télécommande mural / Telecomandode pared



TELO3

TELECOMANDO MULTIPLIO

multiple remote control / Mehrere Fernbedienung
 télécommande multiple / mando a distancia múltiple



TELO4

DIMMER SMART

dimmer / Dimmer / Gradateur / Regulador

Info tecniche p. 10
 Technical information p. 10
 Technische Informationen p. 10
 Informations techniques p. 10
 Informaciones técnicas p.10



DIM03 UE

DIM04 UK

DIM05 CH

DIM06 US



ACCESSORI E RICAMBI

accessories and spare parts / zubehör und ersatzteile / accessoires et pièces de rechange / accesorios y repuestos

KIT ANTIABBAGLIAMENTO

kit anti-glare / Kit Blendschutz
kit antéblouissement / kit anti-deslumbramiento



KIT03

LAMPADINA A RAGGI INFRAROSSI

infrared bulb / infrarot heizelement / ampoule à infrarouge / bombilla infrarrojos



BUL02IMB 1500 W - 230 V

BUL03IMB 2000W - 230V

BUL04IMB 1500W - 110V

BUL05IMB 1500W - 230V LOW GLARE

BUL06IMB 2000W - 230V LOW GLARE

BUL07IMB 1500W - 110V

CAVI CON SPINA

Info tecniche p. 10
Technical information p. 10
Technische Informationen p. 10
Informations techniques p. 10
Informaciones técnicas p.10



	PLUG	CABLE LENGHT (m)	
SC0110	UE	10	
SC0102	UE	2	
SC0203	UK	2	
SC0303	CH	2	
SC0502	AUS	2	
SC0406	US	2	

PESO EXTRA

Extra weight / Poids supplémentaire / Extra Gewicht / Peso Extra

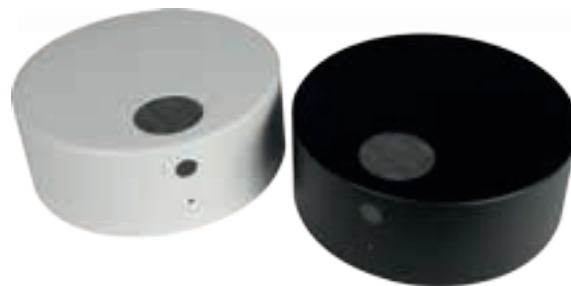

KIT04B WHITE

KIT04N BLACK

KIT04BE BEIGE

ACCESSORI E RICAMBI

accessories and spare parts / zubehör und ersatzteile / accessoires et pièces de rechange / accesorios y repuestos

ATTACCO OMBRELLONE SINGOLO

single umbrella / Einzelsommenschirm / parasol simple / sombrilla única



ADA0101000000	
---------------	--

ATTACCO OMBRELLONE DOPPIO

double umbrella / Doppelsommenschirm / parasol double / sombrilla doble



ADA2101000000	
---------------	--

CONDIZIONI GENERALI DI VENDITA

general sales conditions / allgemeine verkaufsbedingungen / conditions generales de vente
condiciones generales de venta

IT

CONDIZIONI GENERALI
DI VENDITA



01. Le presenti condizioni generali di vendita si intendono integralmente accettate dal cliente con il conferimento dell'ordine. **02.** Gli ordini o gli impegni assunti dai nostri rappresentanti sono validi unicamente dopo nostra accettazione o conferma scritta. **03.** I dati, le misure, gli articoli, i prezzi, le caratteristiche, le prestazioni e tutti gli altri dati riprodotti nei nostri cataloghi, listini, prospetti, circolari ecc. hanno carattere indicativo; essi possono essere variati senza alcun preavviso, e hanno valore vincolante per noi unicamente in caso di espressa indicazione nell'accettazione o nella conferma. **04.** Eventuali reclami o contestazioni non daranno in alcun caso diritto al cliente di omettere o ritardare i pagamenti della fornitura. Per essere validi i reclami dovranno pervenirci entro 8 giorni dalla data di ricevimento della merce. **05.** Il cliente non potrà restituire per alcuna ragione materiale senza nostra espressa autorizzazione scritta. In caso di forza maggiore, ci riserviamo la facoltà di sospendere le consegne e anche di annullare ordini debitamente accettati senza che ciò possa dare diritto al cliente di chiedere qualsivoglia indennizzo o risarcimento danni. **06.** Eventuali ritardi nelle consegne non daranno diritto al cliente ad indennizzi e/o risarcimento danni. Le consegne anche se parziali di merce non possono essere rifiutate dal cliente e non danno diritto all'annullamento dell'ordine. **07.** La resa del materiale s'intende effettuata sempre "franco partenza". Ogni nostra responsabilità cessa con la consegna al cliente od al vettore e quindi il materiale viaggia a rischio e pericolo del cliente. Nei casi in cui, per accordi specifici intervenuti con il cliente, il materiale sia venduto "franco destino" non verranno comunque accettate contestazioni per eventuali furti, rotture o manomissioni. Eventuali accordi con spedizionieri, ivi compreso l'ammontare ed il pagamento del prezzo del

trasporto, s'intenderanno sempre conclusi in nome e per conto del cliente che sin d'ora accetta e ratifica il nostro operato. **08.** Tutti i nostri prodotti vengono accuratamente collaudati in stabilimento; essi sono pertanto coperti da garanzia dai difetti di fabbricazione per un periodo di due anni dalla data di emissione della fattura o della ricevuta fiscale emessa dal rivenditore. **09.** La ditta produttrice s'impegna a riparare o sostituire gratuitamente quelle parti che entro il periodo di garanzia, si dimostrassero difettose di fabbricazione. Difetti non chiaramente attribuibili al materiale o alla fabbricazione verranno esaminati presso il nostro centro di assistenza tecnica e addebitati a seconda dell'esito della verifica. Sono comunque esclusi dalla garanzia: i danni accidentali per trasporto, per incuria, per uso ed installazione errati o non conformi alle avvertenze riportate sul libretto di istruzioni. La garanzia decade qualora l'apparecchio sia stato manomesso o riparato da terzi non autorizzati. In questi casi è esclusa la sostituzione dell'apparecchio ed il prolungamento della garanzia a seguito di intervenuto guasto. Le riparazioni vengono eseguite presso il nostro centro di assistenza tecnica autorizzato; la merce da riparare o sostituire in garanzia deve pervenire presso il centro in porto franco, cioè con spese di trasporto a carico del cliente. **10.** Decliniamo ogni responsabilità per eventuali danni a persone, animali o cose derivanti dall'utilizzo degli apparecchi senza osservanza delle prescrizioni di sicurezza o comunque non installati correttamente e/o installati senza effettuare i controlli d'uso. **11.** I prezzi riportati sul listino si intendono al netto di IVA. **12.** Per qualsiasi controversia derivante da nostra vendita, il contratto sarà disciplinato dalla Legge Italiana, e la competenza sarà unicamente del Foro di Brescia.

EN

GENERAL SALES
CONDITIONS



01. These general sales conditions are considered fully accepted by the customer upon confirmation of the order. **02.** The orders and commitments undertaken by our representatives are only valid following our written acceptance or confirmation. **03.** The data, measurements, articles, prices, features, performance and all other data shown in our catalogues, price lists, prospectuses, circulars etc. are given as an indication only; they may be changed without any warning and are only considered binding for us in the event of their explicit mention in the acceptance or confirmation. **04.** Under no circumstances will any complaints or disputes give the customer any right to omit or delay payments for the delivery. In order for them to be valid, complaints must reach us within 8 days of receipt of the goods. **05.** The customer cannot return the material for any reason without our explicit written authorization. In the event of majeure force, we reserve the right to suspend deliveries and even to cancel duly accepted orders without the customer having any right to ask for any type of compensation or damages. **06.** Any delays in deliveries will not give the customer the right to compensation and/or damages. Deliveries of goods, even if partial, cannot be refused by the customer and do not give the customer the right to cancel the order. **07.** The delivery of material is considered ex works. All our responsibility ceases with delivery to the customer or courier and therefore the material is transported at the customer's own risk. In cases in which, due to specific customer interventions, the material is sold delivered to destination, no disputes will be accepted for any thefts, breakages or tampering. Any agreements with forwarding agents, including the amount and payment of the cost of transportation are considered settled in the name of

and on behalf of the customer who from this moment onwards accepts and approves our conduct. **08.** All our products are carefully tested in our factory, and they are therefore warranted against manufacturing defects for a period of two years from the date of issue of our invoice or from the receipt (or other sale document) issued by the dealer. **09.** The manufacturer undertakes to repair or replace free of charge any parts that within the warranty period should show manufacturing defects. Defects not clearly imputable to materials or making, will be examined by our customer service and charged to the customer according to the results of the inspection. Accidental damage due to transport, due to neglect or incorrect installation or use, or not in compliance with the instructions or warnings contained in our installation hand-book are excluded from the guarantee. The warranty fails if our product has been tampered with or repaired by unauthorized people, and the replacement of the product and the extension of guarantee after occurred failure is excluded. Repairs are carried out by our authorized customer service. The goods to be repaired or replaced under warranty must be received by our customer service free of charge including transport. **10.** We refuse all responsibility for any damage or injury to persons, animals or things deriving from the use of the appliances without observing the safety provisions or from appliances which are not installed correctly and/or have been installed without performing user checks. **11.** The prices shown in the price list do not include VAT. **12.** For any controversy deriving from our sale, the contract will be regulated by Italian Law and the Court of Brescia will have sole competence.

DE



01. Die vorliegenden allgemeinen Verkaufsbedingungen werden mit der erbrachten Auftragsabgabe von dem Kunden vollständig akzeptiert. **02.** Die durch unsere Vertreter angenommenen Aufträge oder Verpflichtungen sind nur dann gültig, wenn sie von uns schriftlich akzeptiert oder bestätigt wurden. **03.** Die Größen, Artikel, Preise, Eigenschaften, Leistungen und alle anderen Auskünfte aus unseren Katalogen, Preislisten, Prospekten, Rundschreiben usw. sind Richtdaten; sie können ohne Vorankündigung geändert werden und sind für uns nur im Falle eines ausdrücklichen Hinweises bei der Annahme oder Bestätigung verbindlich. **04.** Eventuelle Reklamationen oder Beanstandungen geben dem Kunden nicht das Recht die Zahlung der Lieferungen zu unterlassen oder zu verzögern. Damit die Reklamationen gültig sind, müssen sie 8 Tage nach Erhalt der Ware bei uns eingehen.

05. Der Kunde kann ohne unsere ausdrückliche schriftliche Zustimmung auf keinen Fall Material zurückgeben. Im Falle von höherer Gewalt behalten wir uns das Recht vor, Lieferungen einzustellen sowie ordnungsgemäß angenommene Aufträge zu stornieren, ohne, dass dies dem Kunden das Recht gibt Entschädigungen oder Schadensersatz zu fordern. **06.** Eventuelle Verspätungen der Lieferungen geben dem Kunden nicht das Recht, Entschädigungen und/oder Schadensersatz zu fordern. Die Lieferungen, auch nur Teillieferungen, können vom Kunden nicht verweigert werden und geben kein Recht zur Stornierung des Auftrages. **07.** Die Übergabe des Materials ist immer frei ab Werk. Unsere Verantwortung endet mit der Auslieferung an den Kunden oder an das Transportunternehmen, somit gehen Risiko und Gefahr auf den Kunden über. Im Falle, dass aufgrund besonderer Einigungen mit dem Kunden, das Material

DE

ALLGEMEINE
VERKAUFSBEDINGUNGEN

frei Bestimmungsort als verkauft gilt, werden in keinem Fall Beanstandungen wegen eventuellen Diebstahls, Bruchschäden oder Beschädigungen akzeptiert. Eventuelle Absprachen mit Speditionsunternehmen, darin inbegriffen der Betrag und die Zahlung der Transportkosten, gelten immer als abgeschlossen im Namen und für den Kunden, der unsere Handlungen akzeptiert und bestätigt. **08.** Alle unsere Produkte werden im Werk sorgfältig geprüft. Deshalb werden sie gegen Fabrikationsfehler für einen Zeitraum von zwei Jahren ab dem Ausstellungsdatum der Rechnung oder des Steuerbeleges von dem Händler mit einer Garantie gedeckt. **09.** Der Hersteller verpflichtet sich, die Teile zu reparieren oder zu ersetzen, die innerhalb der Garantiezeit Fabrikationsfehler zeigen. Defekte, die nicht deutlich den Material- oder Verarbeitungsfehlern zugeschrieben werden können, werden bei unserem Kundendienst geprüft und nach dem Ergebnis der Überprüfung berechnet. Von der Garantie sind auch zufällige Schäden ausgeschlossen, die dem Transport, Nachlässigkeit, falscher und nicht entsprechender Installation oder der nicht richtiger Nutzung zugeschrieben werden können.

Die Garantie erlischt, falls unerlaubte Dritte das Gerät geöffnet oder repariert haben. In diesem Fall werden das Ersetzen des Gerätes und die Verlängerung der Garantiezeit ausgeschlossen, wenn eventuelle Schäden dazwischen kommen. Reparaturen werden bei unserem autorisierten Kundendienst durchgeführt. Das Gerät, das repariert oder ersetzt werden soll, soll bei unserem Kundendienst frei ankommen, das heißt, auf Kosten des Kunden. **10.** Wir weisen jegliche Verantwortung für Schäden an Personen, Tieren und Sachen zurück, die aus dem Gebrauch der Geräte hervorgehen, ohne dass die Sicherheitsbestimmungen beachtet wurden bzw. die Geräte nicht ordnungsgemäß installiert wurden und/oder installiert wurden, ohne dass Kontrollen erfolgten. **11.** Die auf der Preisliste aufgeführten Preise sind nach Abzug der Mehrwertsteuer zu verstehen. **12.** Für jede Streitigkeit durch unseren Verkauf wird der Vertrag von dem italienischen Gesetz geregelt und der Gerichtsstand ist ausschließlich Brescia.

FR

CONDITIONS GENERALES
DE VENTE

01. Les conditions générales de vente présentes impliquent que le client accepte intégralement ces conditions au moment de l'attribution de la commande. **02.** Les commandes ou les engagements pris par nos agents ne sont valables qu'après notre acceptation ou confirmation écrites. **03.** Les données, les mesures, les articles, les prix, les caractéristiques, les prestations et toutes les autres données indiquées sur nos catalogues, listes des prix, publicités, circulaires etc. sont à titre indicatif, sujets à des variations sans aucun préavis et ils prennent effet uniquement en cas d'acceptation ou de commande. **04.** Réclamations ou contestations éventuelles n'autorisent en aucun cas le client à renoncer ou à retarder les paiements de la fourniture. Pour que les réclamations soient valables, elles doivent nous parvenir sous 8 jours à partir de la date de réception de la marchandise. **05.** Le client ne pourra nous restituer pour aucune raison le matériel sans notre autorisation expresse écrite. En cas de force majeure, nous nous réservons le droit de suspendre les livraisons ou même d'annuler les commandes dûment acceptées sans que cela puisse donner droit au client de mandater un quelconque indemnisation ou un quelconque remboursement des dégâts. **06.** Retards éventuels de livraison ne donnent pas droit au client à des indemnisations et/ou des remboursements pour dommages et intérêts. Les livraisons, même partielles de marchandise ne peuvent pas être refusées par le client et ne donnent pas droit à l'annulation de la commande. **07.** La livraison du matériel est effectuée franco notre usine. Notre responsabilité cesse lors de la livraison au client ou au transporteur et par conséquent la marchandise voyage aux risques du client. Dans les cas où, suite à des accords spécifiques avec le client, le matériel serait vendu "franco d'arrivée", des contestations pour d'éventuels vols, dégâts ou manipulations ne seront pas acceptées. D'éventuels

accords pris avec les transporteurs, concernant le montant et le paiement du prix du transport, seront toujours conclus par le client qui accepte et ratifie notre démarche comme ferme et définitive. **08.** Tous nos produits sont soigneusement testés à l'usine, et ils sont donc garantis contre les défauts de fabrication pour une période de deux ans à compter de la date d'émission de la facture ou du reçu du revendeur. **09.** Le fabricant s'engage à réparer ou à remplacer gratuitement dans la période de garantie, les parties qui montrassent des défauts de fabrication. Défauts pas clairement attribuables aux matériels ou au processus de fabrication seront examinés par notre centre de service et facturé en fonction des résultats de la vérification. Sont exclus de la garantie: les dommages accidentels dus au transport, à la négligence, à l'utilisation et d'installation incorrecte ou non conforme aux instructions de la notice d'entretien. La garantie est nulle si l'appareil a été altéré ou réparé par un tiers non autorisé. Dans ces cas, est exclus le remplacement de l'appareil ou la prolongation de la garantie, si des dommages se vérifient. Les réparations sont effectuées chez notre centre d'assistance technique autorisé: les appareils à réparer ou à remplacer sous garantie doivent être reçus en port franc, c'est à dire à la charge du client. **10.** Nous déclinons toute responsabilité pour des dommages causés à des personnes, animaux ou biens dus à l'utilisation d'appareils sans l'observation des consignes de sécurité ou non installés correctement et/ou sans effectuer les contrôles d'usage. **11.** Les prix reportés sur la liste n'incluent pas la TVA. **12.** Toute controverse dérivant de notre vente, le contrat sera réglé par la Loi Italienne, et le tribunal compétent sera uniquement le Tribunal de Brescia.

ES

CONDITIONS GENERALES
DE VENTA

01. Estas condiciones generales de venta se considera totalmente aceptadas por el cliente en la confirmación del pedido. **02.** Las órdenes o compromisos hechos por nuestros representantes sólo serán válidas después de nuestra aceptación o confirmación por escrito. **03.** Los datos, medidas, artículos, precios, características, prestaciones y demás datos reproducidos en nuestros catálogos, listas de precios, folletos, circulares, etc. son indicativos, están sujetos a cambios sin previo aviso y son vinculantes para nosotros sólo en el caso de cualquier indicación de aceptación o confirmación. **04.** Cualquier reclamación o disputa no dará de ninguna manera derecho al cliente a omitir o demorar el pago de la prestación. Para ser válidas, las reclamaciones deben recibirse dentro de los 8 días siguientes a la recepción de la mercancía. **05.** El cliente no puede devolver el material sin nuestro permiso expreso por escrito. En el caso de disputa, nos reservamos el derecho de suspender las entregas y también de cancelar los pedidos debidamente aceptados sin que el cliente tenga derecho a pedir ninguna compensación o indemnización. **06.** Cualquier retraso en la entrega no dará derecho al cliente a ningún tipo de compensación o indemnización. Incluso en las entregas parciales de la mercancía no pueden ser rechazadas por el cliente y no tienen derecho a cancelar el pedido. **07.** El envío de los materiales siempre se realiza "franco fábrica". Nuestra responsabilidad termina al entregar el material al cliente o a la compañía de transporte, a partir de entonces el material corre por cuenta, cargo y riesgo del cliente. En los casos en que, por acuerdos específicos con el cliente, el material se venda "a portes pagados", en ningún caso, se aceptará ninguna objeción por robo, rotura o deterioro. Los convenios celebrados con transportistas, incluyendo la cantidad y el pago del precio del transporte, se entenderán que van siempre en nombre y a cargo del cliente a partir de que acepta y ratifica nuestra confirmación

de pedido. **08.** Todos nuestros productos son cuidadosamente probados en fábrica, y por lo tanto son garantizados contra defectos de fabricación por un período de dos años a partir de la fecha de emisión de la factura o el recibo expedido por el distribuidor. **09.** El fabricante se compromete a reparar o sustituir gratuitamente las piezas dentro del período de garantía, cuando se considere defecto de fabricación. Los defectos no claramente atribuibles a fabricación de los materiales o mano de obra, serán examinados en nuestro centro de asistencia técnica y en función del resultado se procederá al informe de responsabilidades. Quedan excluidos de la garantía: daños accidentales sufridos por el transporte, negligencia, instalación o utilización incorrecta y el no cumplimiento de las advertencias e indicaciones que aparecen en el folleto de instrucciones. La garantía se anula si la unidad ha sido manipulada o reparada por terceros no autorizados. En estos casos, la sustitución del aparato y la extensión de las garantías quedan intervenidos por las anteriores indicaciones. Las reparaciones se llevan a cabo en nuestro centro de asistencia técnica autorizada, las mercancías que deban ser reparadas o reemplazadas bajo garantía deben ser recibidas en el centro de asistencia técnica debidamente empaquetadas, con los gastos de transporte a cargo del cliente. **10.** Fábrica desestima toda responsabilidad de cualquier daño producido a personas, animales o bienes derivados de la utilización de los equipos que no hayan cumplido con los requisitos de seguridad e instalación correcta, e instalados sin pasar controles de uso. **11.** Los precios de la tarifa son sin IVA. **12.** Para cualquier controversia que surja de nuestra venta, el contrato se regirá por la ley italiana y la competencia será únicamente del Tribunal de Brescia.



PHORMALAB

Via Garibaldi 67/C, Lumezzane, 25065 · Brescia
T · +39.030.871513 – M · info@phormalab.it

WWW.PHORMALAB.IT

