

EDITION 2023

jardinico<sup>®</sup>



jardinico<sup>®</sup>



MADE FOR **SHADE**  
& **OUTDOOR LIVING**



Our aim is to create the space you live in outside. We are a Belgian brand that open doors to the perfect exterior by adding unique and exclusive pieces to your garden or terrace. We want to inspire you and take you to the outdoor experience of your dreams. A serene place where you come together and experience blissful moments with your beloved ones. Complement the outdoors flawlessly with quality materials, the best comfort and finest design.

Our strengths lie in the scope and diversity of our collections. By an allround view on your outdoor area, we are able to offer everything from the best umbrella to your dining table, sunloungers and desired accessories. There are unlimited possibilities, a collection for every style through the wide range of models, colours and finishes.

## OUTDOOR SHADE

### CARACTÈRE

	<b>JCP.1 SERIES</b>	Ambience	10
		Technical	138
UPDATED	<b>JCP.2 SERIES</b>	Ambience	14
		Technical	139
UPDATED	<b>JCP.3 SERIES</b>	Ambience	16
		Technical	142
UPDATED	<b>JCP.4 SERIES</b>	Ambience	20
		Technical	145
	<b>JCP.5 SERIES</b>	Ambience	24
		Technical	150
	<b>JCP.6 SERIES</b>	Ambience	26
		Technical	151

### ATTITUDE

UPDATED	<b>AZORE</b>	Ambience	32
		Technical	152
UPDATED	<b>ANTEGO</b>	Ambience	34
		Technical	153
	<b>KINGSTON</b>	Ambience	38
		Technical	154
NEW	<b>LIMA</b>	Ambience	40
		Technical	155
UPDATED	<b>AMALFI</b>	Ambience	42
		Technical	156
	<b>MALIBU</b>	Ambience	46
		Technical	157
	<b>CUBA</b>	Ambience	50
		Technical	158
	<b>MOOREA</b>	Ambience	52
		Technical	159

## OUTDOOR LIVING

### FURNITURE

NEW	<b>NOA</b>	Ambience	58
		Technical	162
NEW	<b>NERO</b>	Ambience	66
		Technical	167
UPDATED	<b>TUGU</b>	Ambience	72
		Technical	170
	<b>LEGNA</b>	Ambience	78
		Technical	174
UPDATED	<b>SCOOP</b>	Ambience	82
		Technical	178
	<b>MAUROO</b>	Ambience	88
		Technical	180
	<b>TECCA</b>	Ambience	92
		Technical	183
UPDATED	<b>NATURE</b>	Ambience	96
		Technical	186
	<b>FLEXX</b>	Ambience	100
		Technical	188
	<b>VOLTE</b>	Ambience	106
		Technical	194
UPDATED	<b>KUDOS</b>	Ambience	108
		Technical	197
	<b>MANTRA</b>	Ambience	110
		Technical	198
	<b>BYBLOS</b>	Ambience	114
		Technical	200
	<b>NESTING TABLES</b>	Ambience	116
		Technical	201
NEW	<b>BOLSA</b>	Ambience	118
		Technical	203

### DECORATION

UPDATED	<b>POTTERY</b>	Ambience	122
		Technical	204
	<b>LIGHTING</b>	Ambience	126
		Technical	207
	<b>RUGS</b>	Ambience	130
		Technical	208
	<b>POUFS</b>	Ambience	132
		Technical	210
	<b>DECO CUSHIONS</b>	Ambience	134
		Technical	211

### OVERVIEWS

#### CATEGORIES

Dining chairs	212
Benches	213
Bar & counter	213
Dining tables	214
Bistro tables	214
Lounge chairs	215
Sofas	216
Low tables	218
Sunloungers	219
Daybeds	219

#### CARE & MATERIALS

Maintenance	220
Accessories	221
Materials	222





An intuitive view on shade solutions paying tribute to craftsmanship and technical insight was translated into the Caractère collection. A premium outdoor umbrella allowing unlimited shade possibilities and discreet luxury to your garden or terrace. Quality, aesthetics and durability merge together in a modern, chic and demanding world on exterior living.

OUTDOOR LIVING  
CARACTÈRE

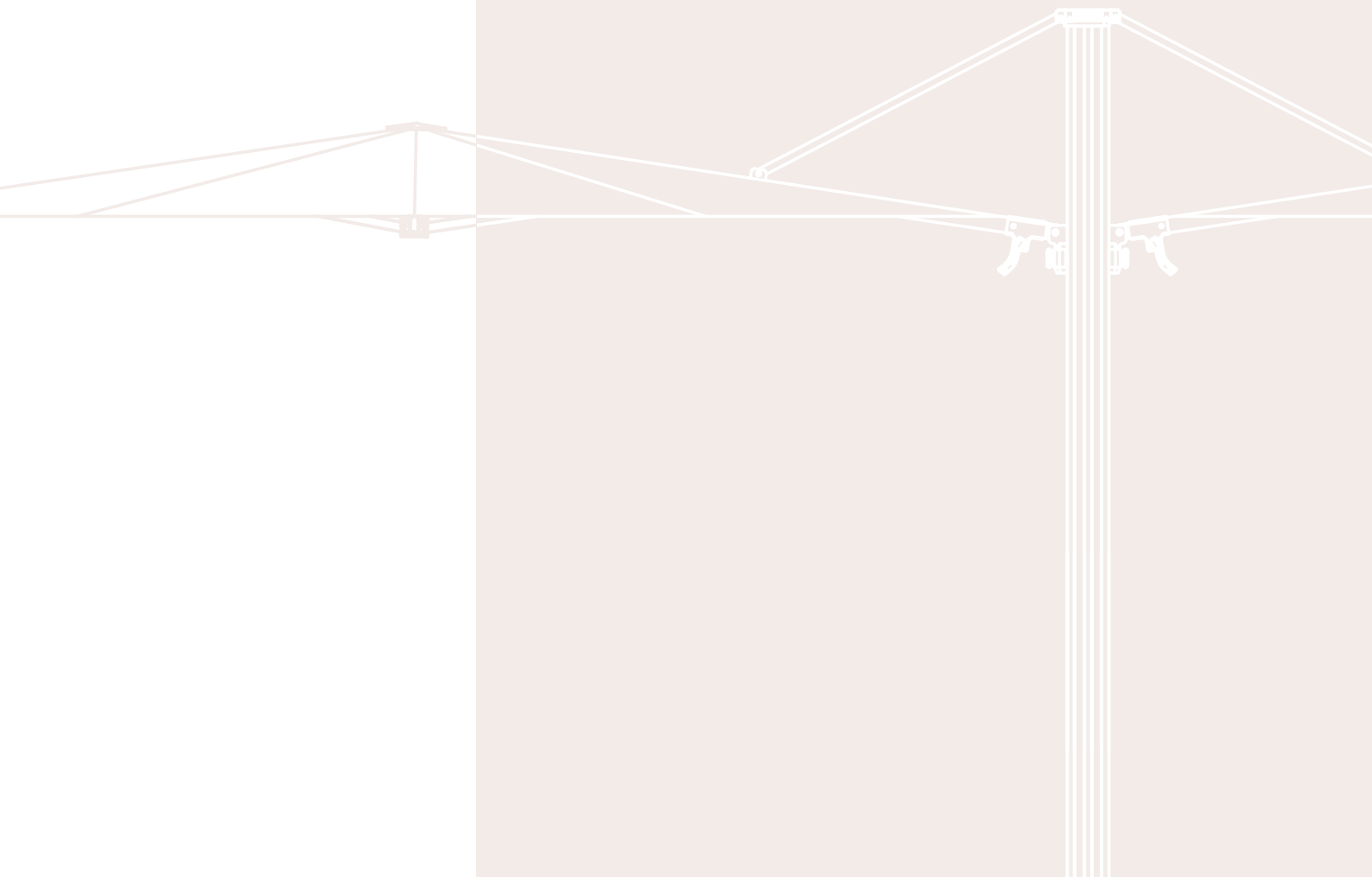



# JCP.1 SERIES

A perfect match for any project around the world, outdoor umbrellas that blend in seamlessly with the environment. Caractère One Series surprises thanks to its sturdiness.

With a canopy incline of 10°, the umbrella looks enormously flat, drawing attention to its sleek lines with an elegant touch.







JCP.102 230 x 230 cm A01 white C011 cotton



JCP.202 500 x 500 cm A01 white C003 pearl - FLEXX bistro





JCP.203 ø 450 cm A01 white C003 pearl - BAY poufs



JCP.201 400 x 400 cm A01 white C003 pearl

## JCP.2 SERIES

Two series offers outdoor umbrellas that play a central role on your patio. A true eye-catcher, providing up to 25m<sup>2</sup> of shade. Thanks to a telescopic system, you can smoothly open and close the sturdy umbrella at arm height without touching other furniture. Despite their enormous strength, the umbrellas are very mobile due to its base.





# JCP.3 SERIES

The most iconic series from Caractère. Three Series includes umbrellas that are the heart of your garden, perfect for shelter and protection from the bright sun rays. Every model is extremely convenient to move and operate. By means of the slider, you can easily move this umbrella into every desired position and turn 360° without having to move its base.



JCP:301 300 x 300 cm A03 linen C011 cotton - NOA dining



JCP:301 300 x 300 cm A01 white C305 umber - NOA lounge - MANTRA director chair - BAY pouf - WILSON rug



JCP303 ø 350 cm A31 charcoal C011 cotton - TUGU lounge - LONGI rug



JCP.301 300 x 300 cm A31 charcoal C100 ice



JCP:401 370 x 370 cm A12 alu teak C011 cotton



# JCP.4 SERIES

Four series is home to a variety of environments all over the world. You may find them in both private use and large projects such as hotels, public buildings, resorts and pool areas.

An exceptionally sturdy outdoor umbrella with an elegant and luxurious appearance. Supported by a 245 kg - 540 lbs base and its dimensions, this series is the perfect marriage between Belgian design, enormous strength and guaranteed quality.







JCP.404 250 x 350 cm A31 charcoal C207 onyx - TECCA dining with YUNA dining armchairs



JCP-501 4\* 300 x 300 cm A12 alu teak C003 pearl







JCP.501 4\* 300 x 300 cm A12 alu teak C003 pearl - FLEXX bistro

# JCP.5 SERIES

Five series has proven to be the ideal model for hospitality. With four separate outdoor umbrellas of 300 x 300 cm on one central pole, this model offers no less than 40m<sup>2</sup> of shade. Each umbrella can be tilted in height and opened individually.

Gutters are available to connect them to each other and enable large areas to have complete, uninterrupted coverage from the sun or rainy weather conditions.



# JCP.6 SERIES

An umbrella that will grace every large outdoor area by its Belgian design. The JCP.601 combines two outdoor umbrellas of 300 x 300 cm that can be opened, closed and tilted in height individually. Together they provide 18m<sup>2</sup> of shade. Thanks to one pole, the space underneath can be used optimally which makes this sunshade ideal for catering projects.



JCP.601 2\* 300 x 300 cm, A10 cappuccino C100 ice - TUGU lounge

JCP.601 2\* 300 x 300 cm A31 charcoal C003 pearl - MAJUOO chaise longues







The Attitude collection includes outdoor umbrellas to suit everyone's preferences. A mid or free pole umbrella, wood or aluminium and a range of available colours for your canopy.

## OUTDOOR SHADE ATTITUDE

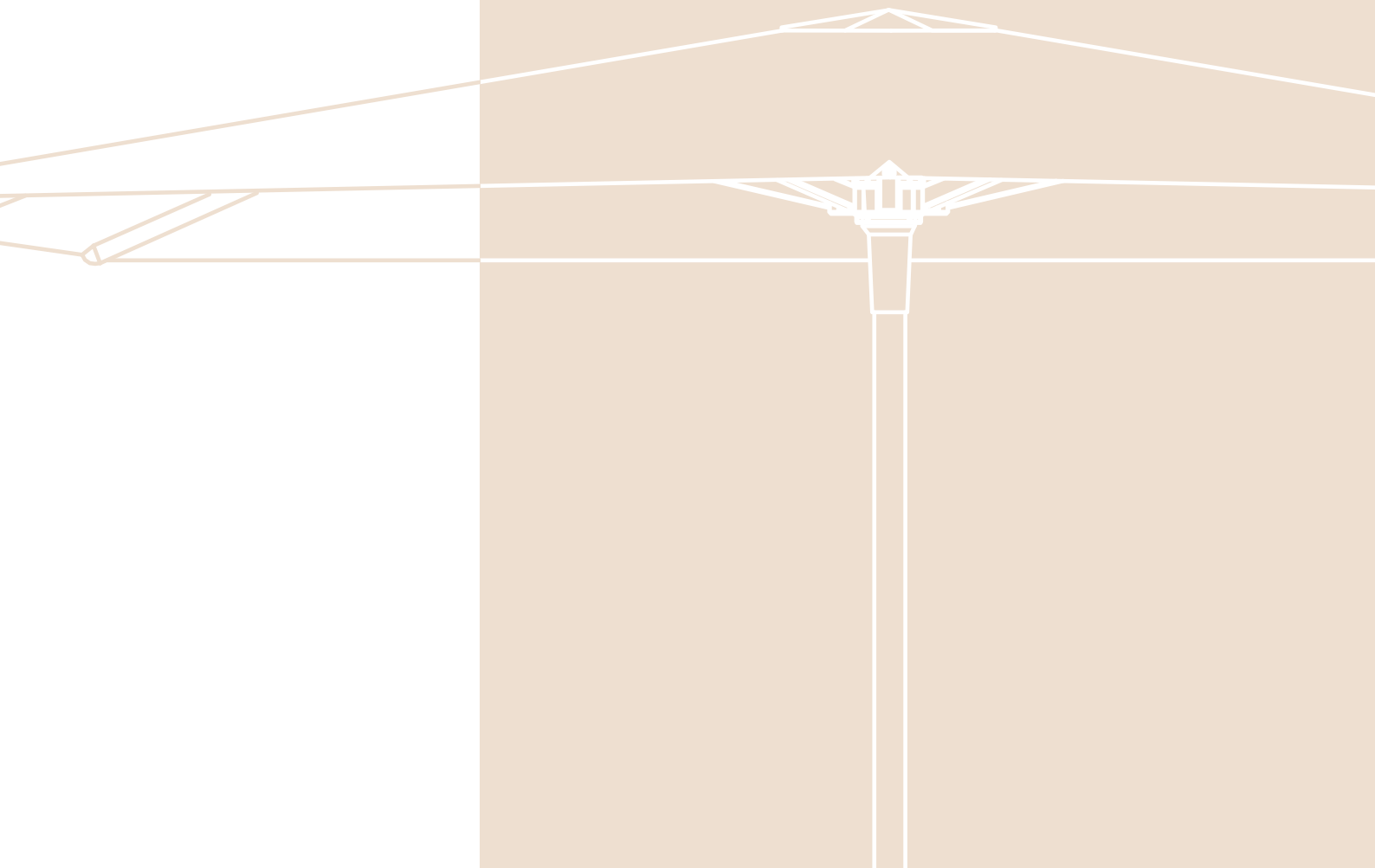

AZORE C04 silk grey granite base

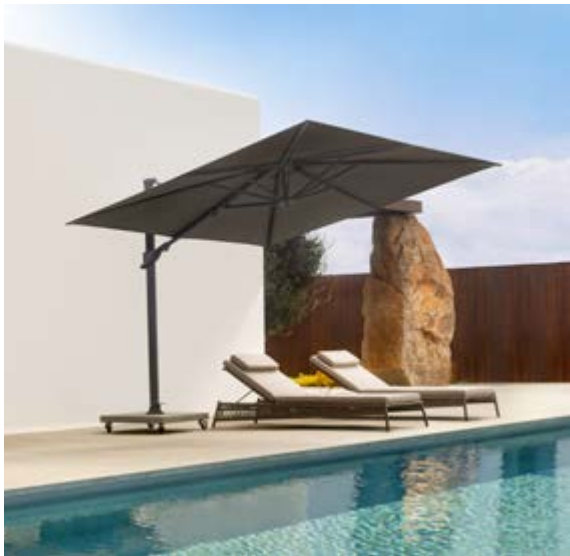

AZORE 300 x 300 cm A30 anthracite C204 night - SCOOP sunloungers







AZORE 300 x 300 cm A32 black C208 black - NATURE dining with LEWIS armchairs

# AZORE

Azore is a free pole umbrella that provides protection on all sunny days. Tilt the umbrella in height with a self-locking tooth belt system at the back of its pole or tilt left and right by means of the crank handle.

The pedal at the bottom of the pole allows you to rotate the umbrella 360° around its axis. Choose a colour combination to your preference and enjoy its sufficient shade on all sunny days, wherever you want on your terrace.



# ANTEGO

Antego offers everything you expect from an outdoor umbrella and does not disappoint. Its operating system allows you to easily move and tilt your umbrella in any desired direction. By means of the pedal at the bottom of the pole, you can rotate the umbrella 360° around its axis.

This outdoor umbrella is developed to complement any outdoor area and give the protection you need all summer long.



ANTEGO ø 300 cm A01 white C001 natural - ANTEGO silk grey granite base - BAY poufs



ANTEGO A12 alu teak



ANTEGO ø 350 cm A32 black C208 black - ANTEGO B32 black concrete base





ANTEGO 300 x 300 cm A12 alu teak C304 walnut - ANTEGO B32 black granite base - MANTRA sunloungers - DONUT pouf





KINGSTON 400 x 400 cm, A32 black, C208 black & G04 silk grey granite base - NATURE dining with TUGU armchairs - ARCO lanterns

# KINGSTON

Kingston is known for its sturdy design and heavy granite base of 300 kg. A large umbrella with a 12 or 16 m<sup>2</sup> canopy that can perfectly cover your entire lounge set and large terrace. The aluminium powder coated frame comes in three colour finishes and a number of colours for its canopy, according to your preference.







# LIMA

Lima, a sturdy umbrella with an elegant look, is the newest addition to the range of Attitude umbrellas.

You can easily open and close the umbrella by means of the crank handle. By means of the rotation pin you can turn the umbrella 360° around its axis.



LIMA 400 x 400 cm A32 black with silk G04 grey granite base - BAY poufs



LIMA 400 x 400 cm A32 black with silk G04 grey granite base - NERO lounge - BAY pouf



AMALFI ø 350 cm A03 linen C211 steel - NOA dining - TUGU chairs - NOA divider - ARCO lanterns - WILSON rug



# AMALFI

The perfect intermediate, fitting both smaller and larger areas. A design that spreads a luxurious appearance and gives the ultimate feeling of comfort, thanks to its push-up system.

Amalfi shows very slim, elegant lines and fits seamlessly into the design of modern urban landscapes, leisure resorts and private homes.



AMALFI 250 x 250 cm A32 black C204 night





AMALFI ø 300 cm A30 anthracite C204 night - 300 x 300 cm A30 anthracite C106 gris nature - 250 x 250 cm A12 alu teak C001 natural - LUCCA heavy bases B30 anthracite





MALIBU 250 x 200 cm A01 white C105 light grey - 240 x 240 cm A12 alu teal C002 white - 210 x 150 cm A30 anthracite C200 dark grey - ø 250 cm A30 anthracite C105 light grey

# MALIBU

A light and practical umbrella, ideal for every smaller terrace or along the swimming pool. You can determine the shade by tilting the umbrella, depending on the position of the sun. Malibu is here for everyone as we offer fourteen different colour combinations, next to six available sizes in a round, square and a rectangular shape. The umbrella is adjustable in height and has a powder coated aluminium frame with a water-repellent canopy.







MALIBU ø 300 cm A32 black C209 coal with LUCCA light base B03 anthracite



MALIBU ø 250 cm A01 white C421 kiwi



MALIBU 200 x 200 cm A01 white C002 white - BAY poufs - TERRA BALLOON pots



CUBA 300 x 300 cm W60 eucalyptus C002 white - FLEXX lounge





# CUBA

Cuba is a timeless classic in the Attitude collection. It shows wood craftsmanship thanks to its frame made of eucalyptus wood with stainless steel, corrosion proof parts.

This umbrella shows its beauty around the globe and is developed to withstand tough, windy conditions in tropical climates.

CUBA ø 350 cm W60 eucalyptus C301 taupe



MOOREA 300 x 300 cm W63 teak scratched C301 taupe - TECCA sunloungers



# MOOREA

An umbrella that is constructed to perform faultlessly and will grace your garden by its sleek and elegant touch. Moorea is finished by a scratched teak frame for a natural and rough finish, including a cord pulley to smoothly open and close the umbrella.

You are able to enjoy the perfect shade for many years to come because of a high performance and protective canopy. Moorea features a heavy duty frame with a diameter of 55 mm and is available with multiple base options.



MOOREA 300 x 300 cm W63 teak scratched C001 natural - NOA sunloungers - DUNCAN teak blocks



Our aim is to create a place to unwind, where you feel the sun and can relax. There are unlimited possibilities, a collection for every style through a wide range of models, colours and finishes.

## OUTDOOR LIVING FURNITURE

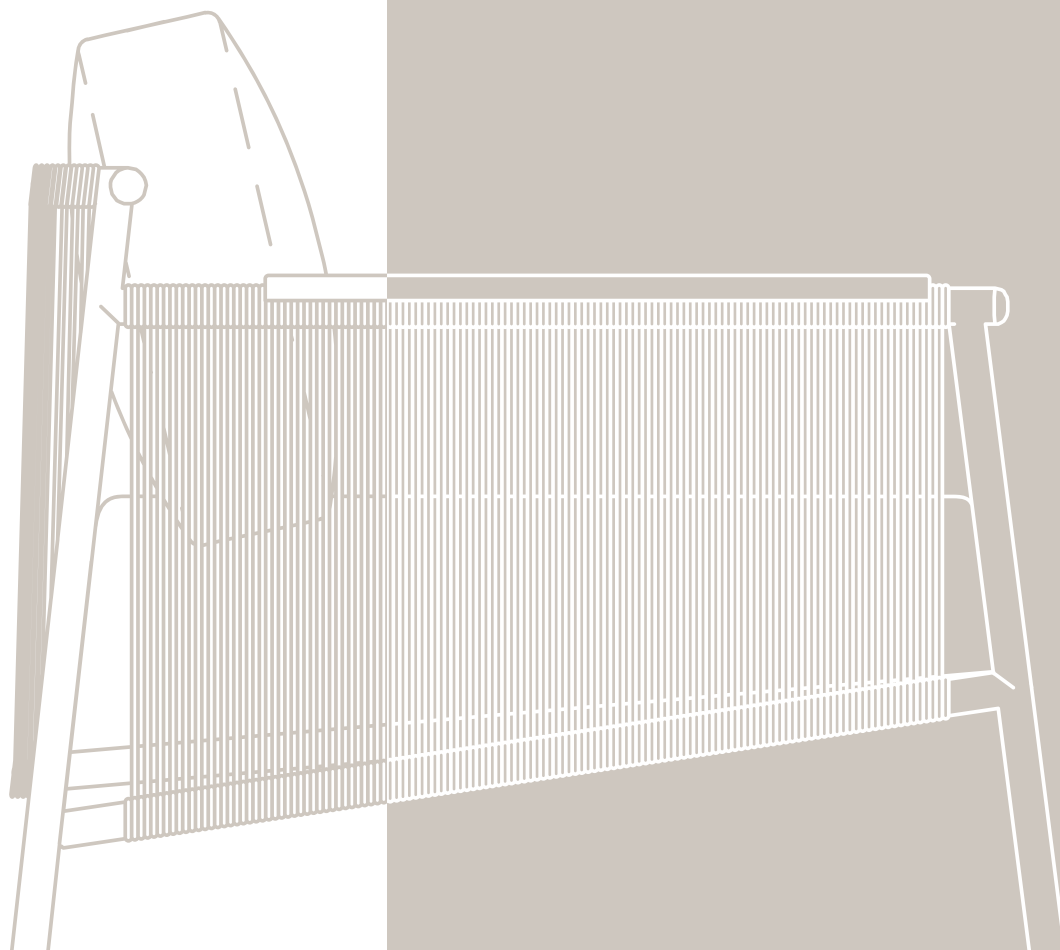



# MEET ENRIQUE

## **DESIGNED BY ENRIQUE MARTI**

Enrique, the founder of Enrique Martí Studio, is an Industrial Design Engineer and holds a Master's in Design and Product Development from Cardenal Herrera, CEU University, Spain.

When he left Andreu World SA in 2006 after nine years with the Spanish company, he was managing the Design and Technical department as Product Manager. Enrique has extensive experience in the furniture business as well as in-depth knowledge of market needs.





### **NOA COLLECTION**

Noa collection, designed by Enrique Marti, establishes an oasis of tranquillity. Creating a calming, serene environment is the aim of this collection and inspired us also on the name of this collection. Noa - Noach which means rest and peace.

Characterised by its curving, the framework is made of natural teak that pays homage to old craftsmanship. The feeling of being close to nature continues thanks to the hand woven strap with a subtle touch of green.

### **SCOOP COLLECTION**

Scoop collection provides elegant grace and develops a neutral touch to emerge with the environment. Its colour and craftsmanship are made for an exceptional view on your garden.





# NOA

Noa collection, designed by Enrique Marti, establishes an oasis of tranquillity. Creating a calming, serene environment is the aim of this collection and inspired us also on the name of this collection. Noa - Noach which means rest and peace.

Characterised by its curving, the framework is made of natural teak that pays homage to old craftsmanship. The feeling of being close to nature continues thanks to the hand woven strap with a subtle touch of green.



NOA dining table 270 x 100 cm - NOA dining chairs & armchairs - CUMINO FIORE pots P18 ruggine



NOA dining table 270 x 100 cm - NOA dining chairs C111 truffle





NOA lounge chairs C111 truffle - NOA side table





NOA sofa 1S, 2S, 3S C015 brûlé - coffee table - sofa side table - side table  
BAY pouf C426 kakki - DECO cushions C422 sage, C430 cotra, C428 azul







NOA sunloungers C111 truffle - side table - divider 180 cm







NERO dining table 300 x 100 cm - dining armchairs C015 brûlé - WILSON rug 250 x 350 cm D78 oyster

# NERO

Nero, a black-teak framed collection that adapts to every kind of exterior, has its focus on comfort and durability. We embraced the challenge of mixing the toughness of black coated teak with the elegance of sand coloured hand woven rope.

Dining armchairs with a curved back ensure a maximum of comfort while dining with your beloved ones.





NERO sofa 1S, 2S, 3S C111 truffle - coffee table - BAY pouf C426 kaki - DECO cushions C401 corn, C431 pacific, C422 sage  
CUMINO FIORE pots P18 ruggine - LIMA umbrella 400 x 400 cm A32 black C208 black - NERO dining





NERO sunloungers C015 brûlé - JCF: 102 230 x 230 cm A12 alu, teak C003 pearl



TUGU sofa 1S, 2S, 3S C008 linen - coffee table ø 90, cm & ø 120, cm & side table ø 45 cm W64 sable teak  
JCP.303 ø 350 cm A31 carcoal C011 cotton - DECO cushions C415 denim - LONGI rug 300 x 400 cm D80 long hair ecru





# TUGU

Tugu collection unveils a new classic that seamlessly connects its design to the surroundings. Unique outdoor furniture pieces with soft contours setting out a balance between a modern and contemporary design with a classic, yet inviting look.

True craftsmanship is brought to life through hand woven wicker portraying an elegant landscape and focusing attention on all details.



TUGU lounge chairs 1S, C008 linen with swivel



TUGU dining chairs W64 sable teak



TUGU dining armchairs C008 linen - CURVO pots P30 caffè



NOA dining table 200 x 100 cm - TUGU dining chairs W62 teak C008 linen - WILSON rug 250 x 350 cm D78 oyster





TUGU coffee table ø 90 cm K14 taupegrey - side table ø 45 cm W62 teak



TUGU sunloungers C008 linen - side table ø 45 cm W64 sable teak





LEGNA dining table K14 taupegrey



# LEGNA

We pay tribute to true craftsmanship that merges perfectly with nature's colours and materials. The ceramic table top is characterized by its intense taupe and grey colours with a subtle pattern and pores. Each piece stands on its own and is not replicable.

The entire collection fits both rustic as well as modern environments and offers maximum comfort.



LEGNA dining table 240 x 100 cm K14 taupegrey - dining armchairs C012 cream - WILSON rug 280 x 390 cm D78 oyster - INTEGRA lanterns





LEGNA chaise longues C012 cream - side table 50 x 35 cm - INTEGRA lanterns - DECO cushion C401 com





LEGNA sofa 1S, 2S, 3S C012 cream - coffee and side table  
DECO cushion C406 pumpkin, C404 diamond - BAY pouf medium C406 pumpkin  
JCF 301 300 x 300 cm A31 charcoal C011 cotton  
WILSON rug 250 x 350 cm D78 oyster





SCOOP sunloungers A01 white C007 beige - DUNCAN teak block - MALIBU 200 x 200 cm A01 white C105 light grey



SCOOP sofa 1S, 2S, 3S A01 white C007 beige - NESTING tables ø 60 cm A01 white W62 teak & ø 75 cm A01 white K14 taupegrey SOLORE lighting F15 natural - BAY pouf C401 com - DECO cushions C401 com, C431 pacific

# SCOOP

Natural and relaxed features, incorporated into sublime quality materials with a sophisticated appearance. Scoop collection provides elegant grace and develops a neutral touch to emerge with the environment. Its colour and craftsmanship are made for an exceptional view on your garden.

Each lounge chair and sofa is surrounded by hand woven rope with a thickness of 4 mm. The aluminium frame, which exists in white and lava, merges beautifully together with the rope and solid wooden armrests.





SCOOP sofa 1S, 2S, 3S A01 white C007 beige - DUNCAN teak blocks - NESTING table ø 40 cm A01 white W62 teak - DECO cushions C431 pacific, C104 quartz





SCOOP sofa 1S, 2S, 3S A14 lava C007 beige - DECO cushions C401 corn, C006 vanilla  
NESTING tables - BAY pouf C006 vanilla - WILSON rug 200 x 300 D78 oyster



SCOOP sunloungers A14 lava C007 beige



SCOOP sofa 1S, 2S, 3S A14 lava C007 beige - DUNCAN teak blocks - BAY poufs  
DECO cushions C401 corn, C006 vanilla - WILSON rug 280 x 390 cm D78 oyster



MAUROO chaise longue, sofa, 2S and long sofa with teak table C202 smoke grey with coffee table - DUNCAN teak block  
VASCO rug 250 x 350 cm D85 aqua - DECO cushions C415 denim, C103 stone



MAUROO long sofa with teak table C006 vanilla



# MAUROO

Mauroo comes with unlimited possibilities, adapted to your choice and preference. Its modular design and versatile use are translated into a unique concept that fits every patio. Choose between two colours for the frame and cushions.

Developed to exceed all expectations, the collection comprises high-performance outdoor cushions with large volume and is supported by an elegant aluminium frame.



MAUROO chaise longue, sofa, 2S, long sofa with teak table and lounge chair 1S C202, smoke grey with coffee table  
VASCO rug 250 x 250 cm D85 aqua - ANTIBES winetub



MAUROO lounge chair - 1S C202 smoke grey - DUNCAN teak block







TECCA dining table 160 x 80 cm with YUNA dining armchairs A03 linen C007 beige



TECCA dining table 320 x 100 cm with YUNA dining armchairs A31 charcoal C205 ebony

# TECCA

Tecca collection creates an open space that breathes warmth by the materials that are selected to be enduring and set the tone. Constructed from aged teak, a unity of materials ensures a visual serenity. The natural earth colour softens the ambience and takes on a sober, yet sophisticated look and feel.

Its solid teak frame, which becomes even more beautiful over time, is supported by an invisible aluminium frame for maximum strength. The dining tables can be matched with chairs from several collections like Yuna, Lewis and Kudos.





TECCA bench 130 x 38 cm - DECO cushion C412 royal



TECCA sunloungers C007 beige - MOOREA 300 x 300 cm W63 teak scratched C301 taupe - KUDOS bistro A01 white



NATURE low dining table 280 x 120 cm with LEWIS low dining armchairs A32 black CO06 vanilla







NATURE dining table 280 x 120 cm with LEWIS dining armchairs C006 vanilla - AZORE 300 x 300 cm A30 anthracite C204 night



# NATURE

This year, we expanded the collection with a low dining concept. These are slightly lower than a traditional dining setting and create a relaxed posture allowing you to enjoy hours of dining that overflows in an endless evening full of joy.

The Lewis low dining armchair, which also exists in a higher version for traditional dining, is made of seagrass rope supported by a powder coated aluminium frame.

The beauty of raw, solid teak makes every piece unique with an irregular touch. All dining tables and benches are carried by a sturdy powder coated aluminium frame for extra support.





NATURE low dining table 280 x 120 cm - LEWIS low dining armchairs A32 black C006 vanilla







FLEXX dining table 300 x 100 cm, dining armchairs C005 marble

# FLEXX

Flexx leaves a lasting impression through its timeless class and quality teak. A collection in which teak plays the leading role by an alternation of clean, elegant and curved lines. All pieces in this collection are suitable for both indoor and outdoor use.

They portray the inviting look of natural teak and signature design of Flexx. A perfect setting to have relaxing moments with family or guests and enjoy your day to the fullest.



FLEXX bar and counter table with accompanying chairs C005 marble - LONGI rug 300 x 400 cm D80 ecru - ANTIBES winecooler



FLEXX sofa 1S, 2S, 3S C005 marble - coffee table



FLEXX lounge chairs 1S C005 marble



FLEXX sunloungers C005 marble







FLEXX daybed C005 marble - side table - JCP.302 260 x 260 cm A10 cappuccino C107 mooncrest



VOLTE sofa 2S A31 charcoal C201 charcoal - NESTING tables



VOLTE dining table K01 white



VOLTE dining table 300 x 100 cm A31 charcoal K31 charcoal - TERRA pots balloon



VOLTE 1S, 3S, 2S A01 white C009 desert - NESTING tables - HAMPTON rug 200 x 300 cm D91 taupe

# VOLTE

First impressions always count. Volte shows soft lines and elegant curves for a sleek look in a contemporary design. Its timeless look and feel transforms your outdoor area into a unique place.

This collection pays homage to the use of natural materials, such as table tops made of natural teak or ceramic tops that are resistant to high temperatures, stains and scratches.



KUDOS bistro tables & chairs A32 black



KUDOS bistro chairs A01 white, A69 lime



# KUDOS

Punctuated by its versatile use and converted from a practical insight, Kudos collection suits a variety of terrace schemes. Constructed from powder coated aluminium, Kudos chair and bistro tables feature a clean and stylish design to offer a sleek and contemporary outdoor solution.

The frivolous and light chair is available in a playful lime colour, elegant linen or timeless black or white. The eclectic mix of colours makes Kudos mesmerising in every bistro setting.



KUDOS bistro tables & chairs A01 white, A03 linen, A32 black



KUDOS bistro chair A03 linen



MANTRA bistro table round & bistro armchairs A30 anthracite



MANTRA bistro table round & director chairs A30 anthracite



MANTRA bistro table round & armchairs A01 white



# MANTRA

Bistro combines minimalism and bespoke solutions to create the best terrace concept. This collection suits perfectly for any small terrace or hospitality project. Combine a heavy aluminium base and table top with hand woven dining armchairs or foldable director chairs.



MANTRA sunloungers A01 white T02 silver - MALIBU 230 x 230 cm A01 white C002 white

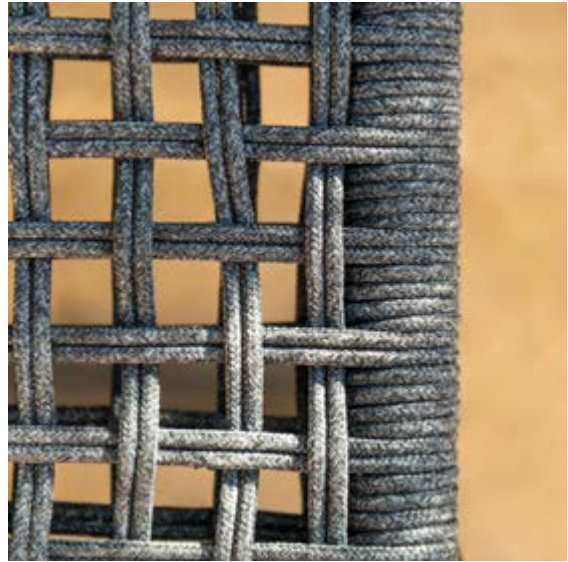

MANTRA bistro table round and armchairs A30 anthracite







BYBLOS beach chairs T30 anthracite



BYBLOS beach chairs T30 anthracite, beach stand W62 teak

# BYBLOS

Slide into your private getaway with the Byblos beach chair and enjoy every sunshine of the day. With four possible positions and a double upholstered seat, we ensure you hours of maximum comfort.

If you would like to store multiple Byblos chairs conveniently, we offer a separate stand which enables you to fit your beach chairs nicely together.



NESTING tables-A01 white K14 taupegrey & W62 teak



DUNCAN teak blocks



# NESTING TABLES

Add a set of accent tables to your lounge area and create that extra touch and space. Mix & match the different sizes & finishes to your preference. Choose out of three different powder coated frame colours and your favourite table top in wood or ceramic.

Choose for a natural style with our traditional Duncan teak block. It is manufactured from natural, untreated, solid teak and can be used in a versatile way as a side table or an additional seat.



DUNCAN teak blocks - NESTING tables A01 white W62 teak, A14 lava K01 white, K31 charcoal



BOLSA lounge chair 1S C428 azul, TUGU coffee table ø 90 cm K14 taupegrey, TUGU side table ø 45 cm W62 teak - JCR.102 230 x 230 cm A12 alu teak C100 ice - LONGI rug ø 300 cm D80 long hair ecru



BOLSA chaise longue C015 brûlé, lounge chair 1S C428 azul

# BOLSA

Playfulness, comfort and cosiness are the ingredients of Bolsa. Whether you use it to unwind by the pool or as an eye-catcher for your outdoor space, this beanbag is always a good idea.

Choose the short model or settle for the long version for a chilly afternoon by the pool.





No outdoor area is complete without a striking accessory. A soft candle light to set a mood once the sun sets, a heavy duty outdoor rug or some poufs that match your furniture cushions perfectly. Choose any size, material or fabric that suits your style and let our range of decoration items add the finishing touch you envisioned to your garden and terrace.

## OUTDOOR LIVING DECORATION





TERRA ALTO pots P11 macchiato



CARTELLO pots P31 marone





CURVO pots set P30 caffè



TERRA BALLOON pots P32 nero

# POTTERY

Each planter is made with natural materials, combined with FRP. All designs and shapes offer the finishing touch to every patio. Enjoy yours for many years to come due to its weather and UV resistance.



CUMINO CALICE pot ø 120 x H 130 cm P01 panna





TERRA CERCHIO ø 112 x H.67 cm P11 macchiato



TERRA CLASSIC pot.ø 150 x H 180 cm P11 macchiato



CUMINO ALBERO set P18 ruggine



CUMINO FUNGO ø 114 x H 54 cm P01 panna



SOLORE sphere set F15 natural - NERO lounge chair 1S C111 truffle - DECO cushion C428 azul





ARCO lanterns



SOLORE cube set F17 taupe

# LIGHTING

Nothing better than a warm outdoor light to make summer evenings more cozy. Our lanterns in teak or aluminium and solar-powered LED lights provide a pleasant atmosphere every single time.



INTEGRA lantern set S99 black & gold

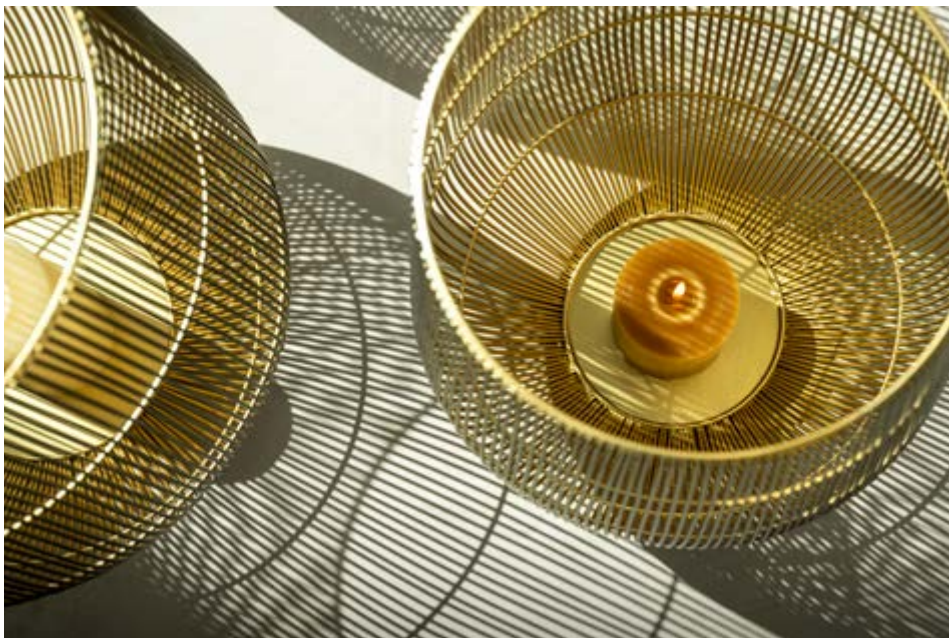





ANTIBES winecooler W62 teak



ANTIBES lanterns set W62 teak



WILSON rug 280 x 390 cm D79 greige - JUTE rug 300 x 400 cm D82 jute - HAMPTON rug 250 x 350 cm D92 grey

# RUGS

A beautiful rug creates a warm environment, even outside in your garden. Go for a chunky one with thick rope or with long hairs for your lounge and a tighter rug for your dining area.



LONGI rug D80 long hair ecru



HAMPTON rugs



JUTE rug D82 jute



WILSON rug D78 oyster



JUTE poufs D82 jute





DONUT\_pouf F14 bohemian



LONGI poufs D81 long hair grey



BAY poufs small, medium & large



HAMPTON poufs small, large

# POUFS

The collection offers a range of sizes from round to square and from small to large poufs. Choose a material, colour and finish to your preference and complete your setting.





DECO cushions C431 pacific, C104 quartz



DECO cushions C428 azul, C422 sage



DECO cushions C006 vanilla, C401 corn

# DECO CUSHIONS

A few outdoor deco cushions create extra cosiness in your garden. Choose energising colours to create a pop of colour or go for earth tones for a more chic and relaxing vibe.





The representation of colours, dimensions and weights may differ from reality as may variations when a product is handmade. Dimensions and technical details are subject to change without prior notice. Jardinico reserves the right to make any improvements such as technological and aesthetical modifications to its models, including adjustments of sizes and materials when it comes to technical developments or availability of raw materials.

# TECHNICAL SPECIFICATIONS

# JCP.1 SERIES

Center pole frame, powder coated aluminium.  
Canopy 100% solution dyed acrylic, 320 gr/m<sup>2</sup>.  
Tilt and rotation not applicable.

## JCP.102 - 230 X 230 CM

max. 43 km/h, 26.7 mph

### UMJCP.102 FRAME & CANOPY

FIXED COMBO			A01C101 white & cloud
			A12C001 alu teal & natural
			A31C101 charcoal & cloud
			A31C204 charcoal & night
			A32C208 black & black

17 kg, 37.5 lbs nett  
excl. base

### UFJCP.102 FRAME

	A01 white		A02 silver
	A03 linen NEW		A12 alu teal
	A31 charcoal		A32 black

MIX & MATCH

### UCJCP.102 CANOPY

	C003 pearl		C011 cotton
	C100 ice		C107 mooncrest
	C207 onyx		C210 pitch
	C305 umber		

Free pick: other fabrics on demand

### UBJCP.1S BASE 44 kg

	S01 white		S02 silver
	S03 linen NEW		S31 charcoal
	S32 black		

UBJCP.1S65 BASE 65 kg (same colours as base 44 kg)

UBIGB-JCP.1S in ground base / UBOGB-JCP.1S on ground base

### COVER

	UPJCP.1S-X77 black
--	--------------------

Push-up hub system

LOXX® system

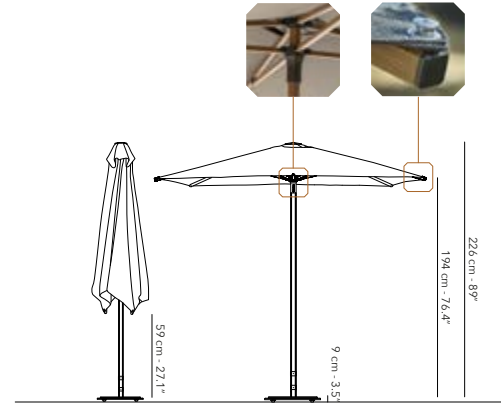

All dimensions exclude the base.

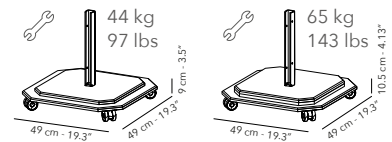
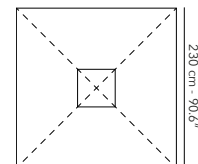
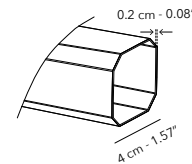

Hot galvanized steel plates, powder coated.  
Four mounted wheels that rotate 360°, each with a brake.  
Has the same colour as its frame. An alu teal frame has a charcoal base.



Center pole frame, powder coated aluminium.  
 Canopy 100% solution dyed acrylic, 320 gr/m<sup>2</sup>.  
 Tilt and rotation not applicable.

# JCP.2 SERIES

max. 58 km/h, 36 mph







## JCP.201 - 400 X 400 CM

### UFJCP.201 FRAME

	A01 white		A02 silver
	A31 charcoal		



MIX & MATCH

### UCJCP.201 CANOPY

	C003 pearl		C011 cotton
	C100 ice		C107 mooncrest
	C207 onyx		C210 pitch
	C305 umber		

Free pick: other fabrics on demand

### UBJCP.2S-3S BASE

	S01 white		S02 silver
	S31 charcoal		

UBIGB-JCP.2S-3S in ground base / UBOGB-JCP.2S-3S on ground base

### COVER

	UPJCP.2S-X77 black
---	--------------------

### GUTTERS

UAJCP.2S colour of the canopy
-------------------------------

56 kg, 123.5 lbs nett  
 excl. base

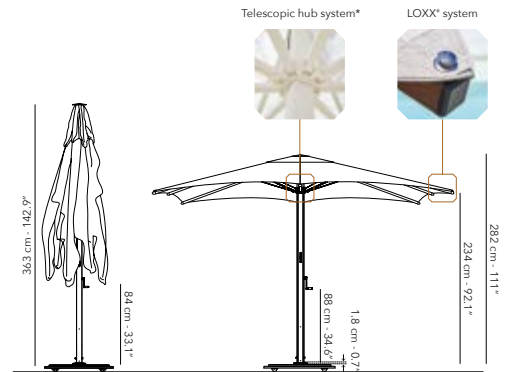

All dimensions exclude the base.  
 \*Easy to open and close without touching furniture.

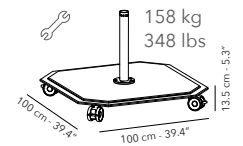
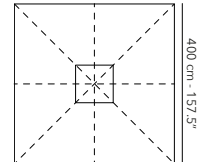
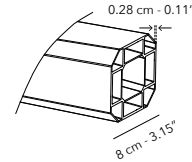

Hot galvanized steel plates, powder coated.  
 Four mounted wheels that rotate 360°, each with a brake.  
 Has the same colour as its frame.



# JCP.2 SERIES

Center pole frame, powder coated aluminium.  
Canopy 100% solution dyed acrylic, 320 gr/m<sup>2</sup>.  
Tilt and rotation not applicable.

## JCP.202 - 500 X 500 CM







max. 58 km/h, 36 mph

### UFJCP.202 FRAME

	A01 white		A02 silver
	A31 charcoal		



MIX & MATCH

### UCJCP.202 CANOPY

	C003 pearl		C011 cotton
	C100 ice		C107 mooncrest
	C207 onyx		C210 pitch
	C305 umber		

Free pick: other fabrics on demand

### UBJCP.2S-3S BASE

	S01 white		S02 silver
	S31 charcoal		

UBIGB-JCP.2S-3S in ground base / UBOGB-JCP.2S-3S on ground base

### COVER

	UPJCP.2S-X77 black
---	--------------------

### GUTTERS

UAJCP.2S colour of the canopy
-------------------------------

56 kg, 123.5 lbs nett  
excl. base

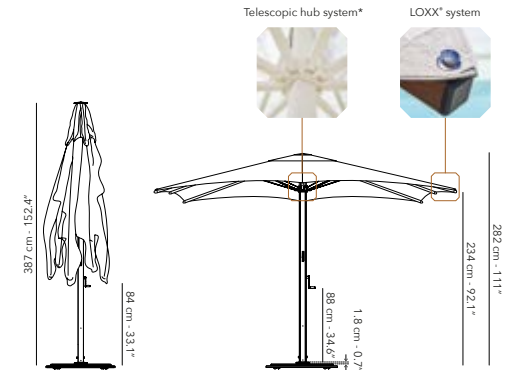

All dimensions exclude the base.  
\* Easy to open and close without touching furniture.

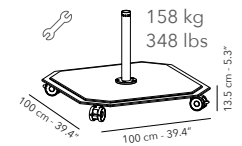
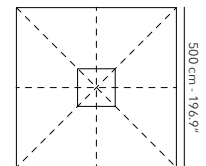
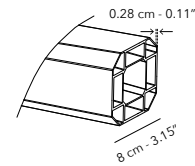

Hot galvanized steel plates, powder coated.  
Four mounted wheels that rotate 360°, each with a brake.  
Has the same colour as its frame.



Center pole frame, powder coated aluminium.  
Canopy 100% solution dyed acrylic, 320 gr/m<sup>2</sup>.  
Tilt and rotation not applicable.

# JCP.2 SERIES

## JCP.203 - Ø 450 CM







max. 58 km/h, 36 mph

### UFJCP.203 FRAME

	A01 white		A02 silver
	A31 charcoal		



MIX & MATCH

### UCJCP.203 CANOPY

	C003 pearl		C011 cotton
	C100 ice		C107 mooncrest
	C207 onyx		C210 pitch
	C305 umber		

Free pick: other fabrics on demand

### UBJCP.2S-3S BASE

	S01 white		S02 silver
	S31 charcoal		

UBIGB-JCP.2S-3S in ground base / UBOGB-JCP.2S-3S on ground base

### COVER

	UPJCP.2S-X77 black
---	--------------------

42 kg, 92.6 lbs nett  
excl. base

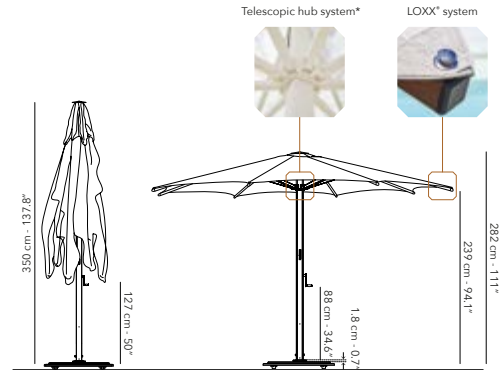

All dimensions exclude the base.  
\* Easy to open and close without touching furniture.

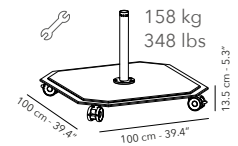
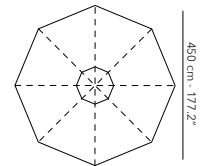
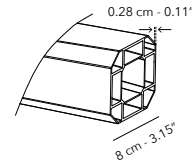

Hot galvanized steel plates, powder coated.  
Four mounted wheels that rotate 360°, each with a brake.  
Has the same colour as its frame.

# JCP.3 SERIES

Free pole frame, powder coated aluminium.  
Canopy 100% solution dyed acrylic, 320 gr/m<sup>2</sup>.  
Tilt in height, left and right, rotation 360°.

## JCP.301 - 300 X 300 CM



max. 58 km/h, 36 mph

### UMJCP.301 FRAME & CANOPY

FIXED COMBO			A01C101 white & cloud
			A12C001 alu teal & natural
			A31C101 charcoal & cloud
			A31C204 charcoal & night
			A32C208 black & black

### UFJCP.301 FRAME

	A01 white		A02 silver
	A03 linen NEW		A10 cappuccino
	A12 alu teal		A31 charcoal
	A32 black		

MIX & MATCH

### UCJCP.301 CANOPY

	C003 pearl		C011 cotton
	C100 ice		C107 mooncrest
	C207 onyx		C210 pitch
	C305 umber		

Free pick: other fabrics on demand

### UBJCP.2S-3S BASE

	S01 white		S02 silver
	S03 linen NEW		S31 charcoal
	S32 black		

UBIGB-JCP.2S-3S in ground base / UBOGB-JCP.2S-3S on ground base

### COVER

	UPJCP.3S-X77 black
--	--------------------

42 kg, 92.6 lbs nett  
excl. base

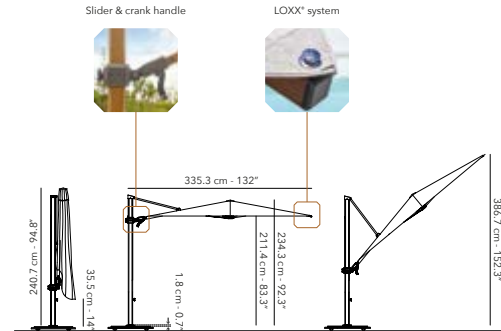

All dimensions exclude the base.

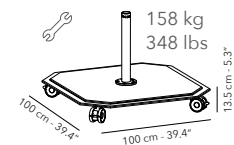
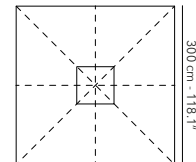
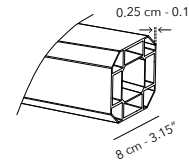

Hot galvanized steel plates, powder coated.  
Four mounted wheels that rotate 360°, each with a brake.  
Has the same colour as its frame.  
An alu teal or cappuccino frame has a charcoal base.

Free pole frame, powder coated aluminium.  
 Canopy 100% solution dyed acrylic, 320 gr/m<sup>2</sup>.  
 Tilt in height, left and right, rotation 360°.

# JCP.3 SERIES

## JCP.302 - 260 X 260 CM



max. 58 km/h, 36 mph

### UMJCP.302 FRAME & CANOPY

FIXED COMBO			A01C101 white & cloud
			A12C001 alu teal & natural
			A31C101 charcoal & cloud
			A31C204 charcoal & night

### UFJCP.302 FRAME

	A01 white		A02 silver
	A10 cappuccino		A12 alu teal
	A31 charcoal		

MIX & MATCH

### UCJCP.302 CANOPY

	C003 pearl		C011 cotton
	C100 ice		C107 mooncrest
	C207 onyx		C210 pitch
	C305 umber		

Free pick: other fabrics on demand

### UBJCP.2S-3S BASE

	S01 white		S02 silver
	S31 charcoal		

UBIGB-JCP.2S-3S in ground base / UBOGB-JCP.2S-3S on ground base

### COVER

	UPJCP.3S-X77 black
--	--------------------

31 kg, 68.3 lbs nett  
 excl. base

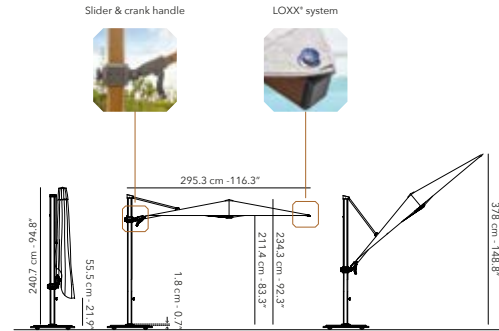

All dimensions exclude the base.

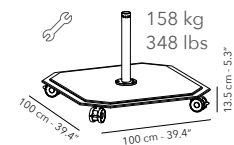
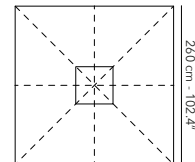
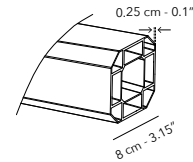

Hot galvanized steel plates, powder coated.  
 Four mounted wheels that rotate 360°, each with a brake.  
 Has the same colour as its frame.  
 An alu teal or cappuccino frame has a charcoal base.

# JCP.3 SERIES

Free pole frame, powder coated aluminium.  
Canopy 100% solution dyed acrylic, 320 gr/m<sup>2</sup>.  
Tilt in height, left and right, rotation 360°.

## JCP.303 - Ø 350 CM



max. 58 km/h, 36 mph

### UFJCP.303 FRAME

	A01 white		A02 silver
	A10 cappuccino		A12 alu teak
	A31 charcoal		

MIX & MATCH

### UCJCP.303 CANOPY

	C003 pearl		C011 cotton
	C100 ice		C107 mooncrest
	C207 onyx		C210 pitch
	C305 umber		

Free pick: other fabrics on demand

### UBJCP.2S-3S BASE

	S01 white		S02 silver
	S31 charcoal		

UBIGB-JCP.2S-3S in ground base / UBOGB-JCP.2S-3S on ground base

### COVER

	UPJCP.3S-X77 black
--	--------------------

17 kg, 37.5 lbs nett  
excl. base

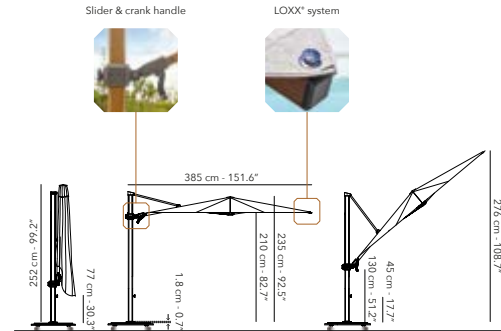

All dimensions exclude the base.

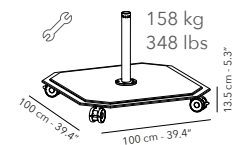
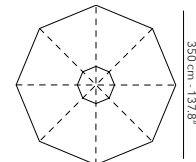
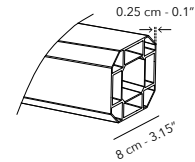

Hot galvanized steel plates, powder coated.  
Four mounted wheels that rotate 360°, each with a brake.  
Has the same colour as its frame.  
An alu teak or cappuccino frame has a charcoal base.



Free pole frame, powder coated aluminium.  
 Canopy 100% solution dyed acrylic, 320 gr/m<sup>2</sup>.  
 Tilt in height, left and right, rotation 360°.

# JCP.4 SERIES

## JCP.401 - 370 X 370 CM



360°

max. 58 km/h, 36 mph

### UMJCP.401 FRAME & CANOPY

FIXED COMBO			A01C101 white & cloud
			A12C001 alu teal & natural
			A31C101 charcoal & cloud
			A31C204 charcoal & night
			A32C208 black & black

### UFJCP.401 FRAME

MIX & MATCH		A01 white		A02 silver
		A03 linen NEW		A10 cappuccino
		A12 alu teal		A31 charcoal
		A32 black		

### UCJCP.401 CANOPY

MIX & MATCH		C003 pearl		C011 cotton
		C100 ice		C107 mooncrest
		C207 onyx		C210 pitch
		C305 umber		

Free pick: other fabrics on demand

### UBJCP.4S BASE

	S01 white		S02 silver
	S03 linen NEW		S31 charcoal
	S32 black		

UBIGB-JCP.4S-5S-6S in ground base / UBOGB-JCP.4S-5S-6S on ground base

### COVER

	UPJCP.4S-X77 black
--	--------------------

64 kg, 141.1 lbs nett  
 excl. base

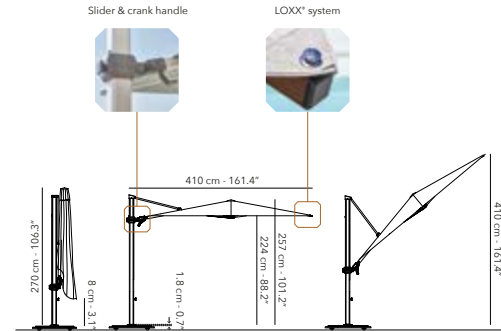

All dimensions exclude the base.

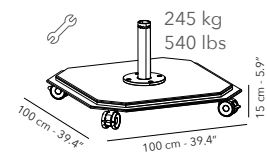
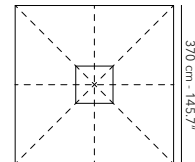
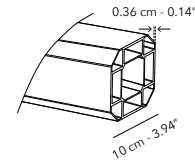

Hot galvanized steel plates, powder coated.  
 Four mounted wheels that rotate 360°, each with a brake.  
 Has the same colour as its frame.  
 An alu teal or cappuccino frame has a charcoal base.

# JCP.4 SERIES

Free pole frame, powder coated aluminium.  
Canopy 100% solution dyed acrylic, 320 gr/m<sup>2</sup>.  
Tilt in height, left and right, rotation 360°.

## JCP.402 - 425 X 300 CM



max. 58 km/h, 36 mph

### UFJCP.402 FRAME

	A01 white		A02 silver
	A10 cappuccino		A12 alu teak
	A31 charcoal		

MIX & MATCH

### UCJCP.402 CANOPY

	C003 pearl		C011 cotton
	C100 ice		C107 mooncrest
	C207 onyx		C210 pitch
	C305 umber		

Free pick: other fabrics on demand

### UBJCP.4S BASE

	S01 white		S02 silver
	S31 charcoal		

UBIGB-JCP.4S-5S-6S in ground base / UBOGB-JCP.4S-5S-6S on ground base

### COVER

	UPJCP.4S-X77 black
--	--------------------

53 kg, 116.8 lbs nett  
excl. base

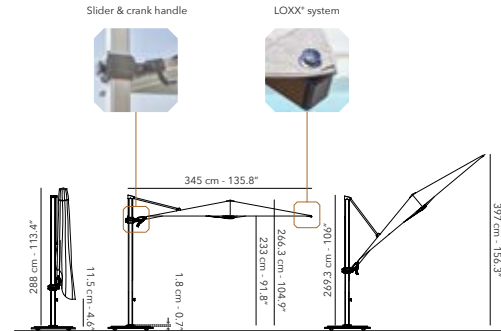

All dimensions exclude the base.

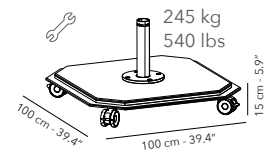
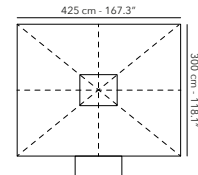
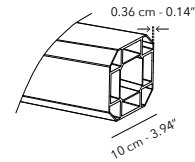

Hot galvanized steel plates, powder coated.  
Four mounted wheels that rotate 360°, each with a brake.  
Has the same colour as its frame.  
An alu teak or cappuccino frame has a charcoal base.

Free pole frame, powder coated aluminium.  
 Canopy 100% solution dyed acrylic, 320 gr/m<sup>2</sup>.  
 Tilt in height, left and right, rotation 360°.

# JCP.4 SERIES

## JCP.403 - Ø 400 CM



max. 58 km/h, 36 mph

### UFJCP.403 FRAME

	A01 white		A02 silver
	A10 cappuccino		A12 alu teal
	A31 charcoal		

MIX & MATCH

### UCJCP.403 CANOPY

	C003 pearl		C011 cotton
	C100 ice		C107 mooncrest
	C207 onyx		C210 pitch
	C305 umber		

Free pick: other fabrics on demand

### UBJCP.4S BASE

	S01 white		S02 silver
	S31 charcoal		

UBIGB-JCP.4S-5S-6S in ground base / UBOGB-JCP.4S-5S-6S on ground base

### COVER

	UPJCP.4S-X77 black
--	--------------------

53 kg, 116.8 lbs nett  
 excl. base

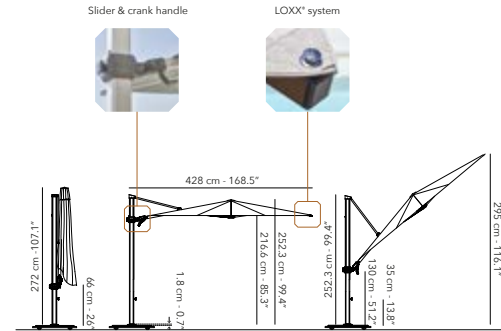

All dimensions exclude the base.

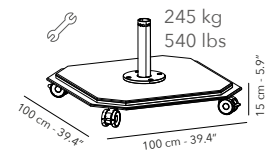
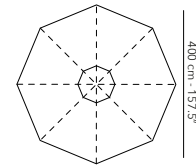
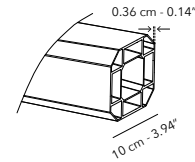

Hot galvanized steel plates, powder coated.  
 Four mounted wheels that rotate 360°, each with a brake.  
 Has the same colour as its frame.  
 An alu teal or cappuccino frame has a charcoal base.

# JCP.4 SERIES

Free pole frame, powder coated aluminium.  
Canopy 100% solution dyed acrylic, 320 gr/m<sup>2</sup>.  
Tilt in height, left and right, rotation 360°.

## JCP.404 - 250 X 350 CM



max. 58 km/h, 36 mph

### UFJCP.404 FRAME

	A01 white		A02 silver
	A10 cappuccino		A12 alu teak
	A31 charcoal		

MIX & MATCH

### UCJCP.404 CANOPY

	C003 pearl		C011 cotton
	C100 ice		C107 mooncrest
	C207 onyx		C210 pitch
	C305 umber		

Free pick: other fabrics on demand

### UBJCP.45 BASE

	S01 white		S02 silver
	S31 charcoal		

UBIGB-JCP.45-5S-6S in ground base / UBOGB-JCP.45-5S-6S on ground base

### COVER

	UPJCP.45-X77 black
--	--------------------

60 kg, 132.3 lbs nett  
excl. base

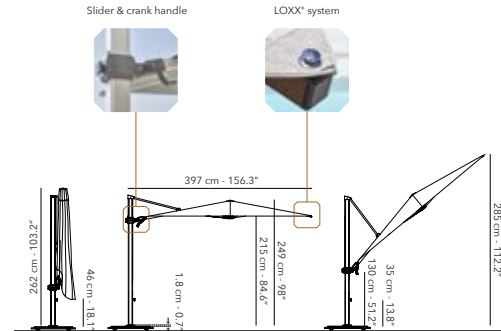

All dimensions exclude the base.

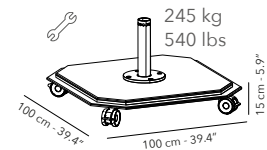
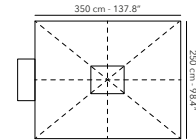
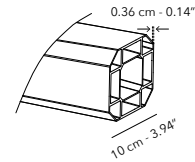

Hot galvanized steel plates, powder coated.  
Four mounted wheels that rotate 360°, each with a brake.  
Has the same colour as its frame. An alu teak frame has a charcoal base.



# JCP.5 SERIES

Free pole frame, powder coated aluminium.  
Canopy 100% solution dyed acrylic, 320 gr/m<sup>2</sup>.  
Tilt in height, left and right, rotation 360°.

## JCP.501 - 4\* 300 X 300 CM



max. 58 km/h, 36 mph

### UFJCP.501 FRAME

	A02 silver		A12 alu teal
	A31 charcoal		

143.5 kg, 316.4 lbs nett  
excl. base

MIX & MATCH

### UCJCP.501 CANOPY

	C003 pearl		C011 cotton
	C100 ice		C107 mooncrest
	C207 onyx		C210 pitch
	C305 umber		

Free pick: other fabrics on demand

### UBJCP.5S-6S BASE

	S02 silver		S31 charcoal
--	------------	--	--------------

UBIGB-JCP.4S-5S-6S in ground base / UBQGB-JCP.4S-5S-6S on ground base

### COVER

	UPJCP.5S-X77 black
--	--------------------

### UAJCP.5S GUTTERS (4x)

A fabric from mix & match / other fabric of your choice

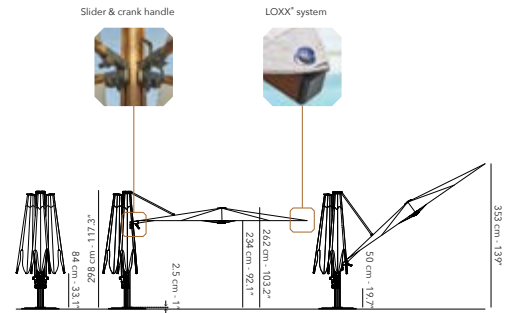

All dimensions exclude the base.

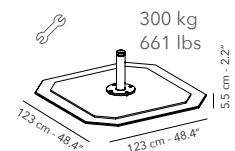
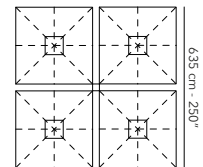
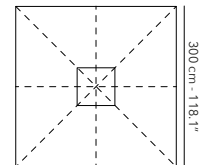
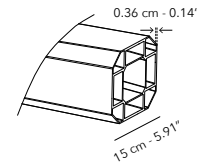

Hot galvanized steel plates, powder coated.  
Base without wheels.  
Has the same colour as its frame.  
An alu teal frame has a charcoal base.

Free pole frame, powder coated aluminium.  
 Canopy 100% solution dyed acrylic, 320 gr/m<sup>2</sup>.  
 Tilt in height, left and right, rotation 360°.

# JCP.6 SERIES

## JCP.601 - 2\* 300 X 300 CM



max. 58 km/h, 36 mph

### UFJCP.601 FRAME

	A10 cappuccino		A12 alu teal
	A31 charcoal		

MIX & MATCH

### UCJCP.601 CANOPY

	C003 pearl		C011 cotton
	C100 ice		C107 mooncrest
	C207 onyx		C210 pitch
	C305 umber		

Free pick: other fabrics on demand

### UBJCP.5S-6S BASE

	S02 silver		S31 charcoal
--	------------	--	--------------

UBIGB-JCP.4S-5S-6S in ground base / UBOGB-JCP.4S-5S-6S on ground base

### COVER

	UPJCP.6S-X77 black
--	--------------------

86.5 kg, 190.7 lbs nett  
 excl. base

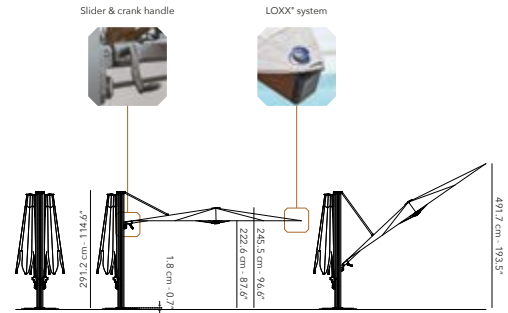

All dimensions exclude the base.

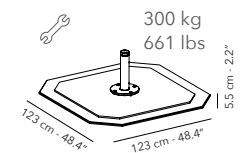
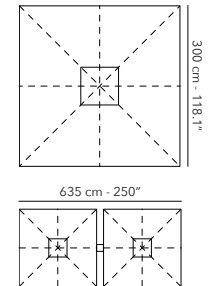
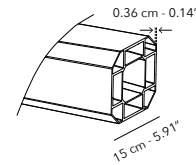

Hot galvanized steel plates, powder coated.  
 Base without wheels.  
 Has the same colour as its frame.  
 An alu teal or cappuccino frame has a charcoal base.

# AZORE

## UPDATED with base plate

Free pole frame, powder coated aluminium.  
Canopy is weatherproof and colour resistant.  
Tilt in height, left and right, rotation 360°.

**AZORE** fully assembled (excl. base)



max. 27 km/h, 17 mph

### UMAZO FRAME & CANOPY

		A01C101 white & cloud
		A30C204 anthracite & night
		A32C208 black & black

### UB BASE

	AZO-125CA-G04 azore
--	---------------------

IGB-AZO-4G-MEDIUM in ground base

OGB-AZO-4G-MEDIUM on ground base

### UP COVER

AZO-M-X75 grey
----------------

### UA ACCESSORIES

LUN-LED02 Luna LED light
--------------------------

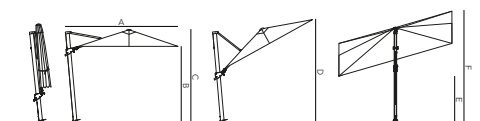
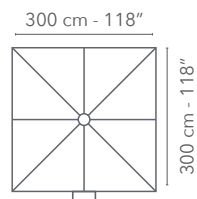

300 X 300 CM

	27 kg - 59.5 lbs nett excl. base
A	375 cm - 147.6"
B	203 cm - 79.9"
C	262 cm - 103.1"
D	355 cm - 139.8"
E	130 cm - 51.2"
F	300 cm - 118.1"



300 x 300 cm



Free pole frame, powder coated aluminium.  
Canopy is weatherproof and colour resistant.  
Tilt in height, left and right, rotation 360°.

# ANTEGO

## ANTEGO



max. 39 km/h, 24 mph

### UFANT FRAME

	A01 white		A02 silver*
	A03 linen		A11 taupe
	A12 alu teak		A14 lava NEW
	A30 anthracite		A32 black

\* only available in 300 x 300 cm

### UCANT CANOPY

	C001 natural		C010 latte
	C101 cloud		C106 gris nature
	C204 night		C208 black
	C211 steel		C212 gasoline NEW
	C301 taupe		C304 walnut
	C402 tangerine		C409 brick
	C417 jeans		C424 spinach

Free pick: other fabrics on demand

### UB BASE

	ANT-125-B03 / B32 concrete base
	ANT-125CA-G04 silk grey granite
OPTIONAL	ANT-EW60-G04 silk grey granite tiles
	ANT-125-G13 sandstone
	ANT-125-G32 black granite

IGB-FP-5G-MEDIUM in ground base

OGB-FP-5G-MEDIUM on ground base

### UP COVER

ANT-M-X75 grey

### UA ACCESSORIES

LUN-LED02 Luna LED light

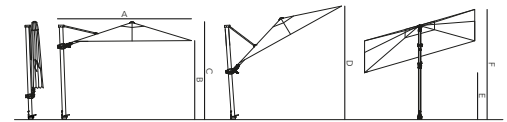
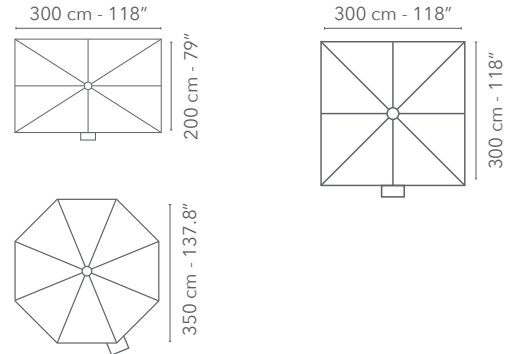

	300 X 200 CM	300 X 300 CM	Ø 350 CM
	33 kg - 72.8 lbs nett excl. base	34 kg - 75 lbs nett excl. base	35 kg - 77.1 lbs nett excl. base
A	275 cm - 108.3"	375 cm - 147.6"	427 cm - 168.1"
B	203 cm - 79.9"	203 cm - 79.9"	188 cm - 74"
C	262 cm - 103.1"	262 cm - 103.1"	261 cm - 102.8"
D	280 cm - 110"	355 cm - 139.8"	441 cm - 173.6"
E	130 cm - 51.2"	130 cm - 51.2"	130 cm - 51.2"
F	300 cm - 118.1"	300 cm - 118.1"	375 cm - 92.5"

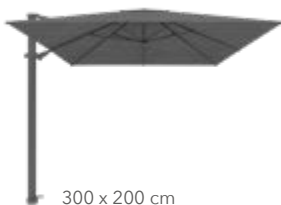

# KINGSTON

Free pole frame, powder coated aluminium.  
Canopy is weatherproof and colour resistant.  
Tilt in height, rotation 360°.

## KINGSTON



max. 45 km/h, 28 mph

### UFKIN FRAME

	A01 white		A30 anthracite
	A32 black		

### UCKIN CANOPY

	C001 natural		C010 latte
	C101 cloud		C106 gris nature
	C204 night		C208 black
	C211 steel		C212 gasoline <b>NEW</b>
	C301 taupe		C304 walnut
	C402 tangerine		C409 brick
	C417 jeans		C424 spinach

Free pick: other fabrics on demand

### UB BASE

	KIN-300-G04 silk grey granite
--	-------------------------------

IGB-FP-LARGE in ground base

OGB-FP-LARGE on ground base

### UP COVER

KIN-L-X75 grey
----------------

### UA ACCESSORIES

LUN-LED02 Luna LED light
--------------------------

400 cm - 157.5"

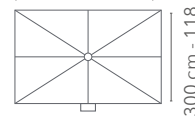

400 cm - 157.5"

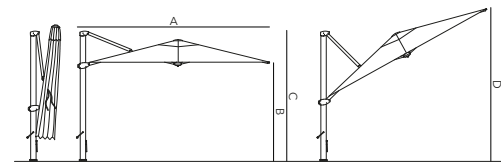
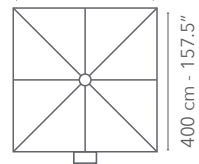

	400 X 300 CM	400 X 400 CM
	46 kg - 101.4 lbs nett excl. base	54 kg - 119 lbs nett excl. base
A	364 cm - 106.7"	464 cm - 182.7"
B	240 cm - 94.5"	240 cm - 94.5"
C	290 cm - 114.2"	290 cm - 114.2"
D	384 cm - 151.2"	364 cm - 143.3"



Free pole frame, powder coated aluminium.  
Canopy is weatherproof and colour resistant.  
Tilt in height, rotation 360°.

# LIMA

## NEW

### LIMA



max. 45 km/h, 28 mph

#### UFLIM FRAME

	A01 white		A03 linen
	A30 anthracite		A32 black

#### UCLIM CANOPY

	C001 natural		C010 latte
	C101 cloud		C106 gris nature
	C204 night		C208 black
	C211 steel		C212 gasoline <b>NEW</b>
	C301 taupe		C304 walnut
	C402 tangerine		C409 brick
	C417 jeans		C424 spinach

Free pick: other fabrics on demand

#### UB BASE

	KIN-300-G04 silk grey granite
--	-------------------------------

IGB-FP-LARGE in ground base

OGB-FP-LARGE on ground base

#### UP COVER

KIN-L-X75 grey
----------------

#### UA ACCESSORIES

LUN-LED02 Luna LED light
--------------------------

400 cm - 157.5"

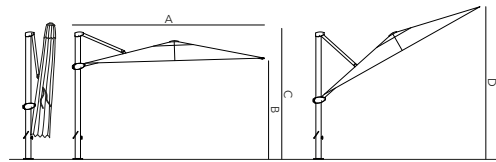
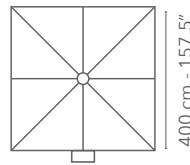

400 X 400 CM

	54 kg - 119 lbs nett excl. base
A	464 cm - 182.7"
B	240 cm - 94.5"
C	290 cm - 114.2"
D	364 cm - 143.3"



400 x 400 cm

# AMALFI





UPDATED

Mid pole frame, powder coated aluminium.  
Canopy is weatherproof and colour resistant.  
Diameter of the pole:  $\varnothing$  40 mm, 1.6".

























## AMALFI

max. 39 km/h, 24 mph

### UFAMA FRAME



	A01 white		A03 linen
	A12 alu teal		A30 anthracite
	A32 black		

### UCAMA CANOPY

	C001 natural			C010 latte	
	C101 cloud			C106 gris nature	
	C204 night			C208 black	
	C211 steel			C212 gasoline <b>NEW</b>	
	C301 taupe			C304 walnut	
	C402 tangerine			C409 brick	
	C417 jeans			C424 spinach	

Free pick: other fabrics on demand

### UB BASE

	ELB-44-S01 / -S03 / -S31 elba medium
	LUC-60-B01 / -B30 lucca heavy
OPTIONAL	UALUC-WHE.60 lucca heavy wheels

IGB-MP-SMALL in ground base

### UP COVER

AMA-M-X75 grey
----------------

### UA ACCESSORIES

LUN-LED02 Luna LED light
--------------------------

250 cm - 98.4"

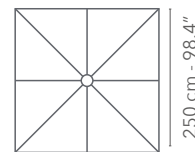

250 cm - 98.4"

300 cm - 118"

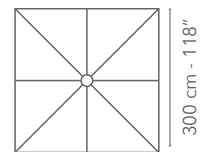

300 cm - 118"

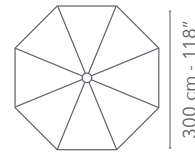

300 cm - 118"

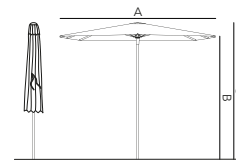

	250 X 250 CM	300 X 300 CM	$\varnothing$ 300 CM
	14.9 kg - 32.8 lbs nett excl. base	17 kg - 37.5 lbs nett excl. base	17 kg - 37.5 lbs nett excl. base
A	250 cm - 98.4"	300 cm - 118.1"	300 cm - 118.1"
B	216 cm - 85"	216 cm - 85"	216 cm - 85"
C	250 cm - 98.4"	250 cm - 98.4"	250 cm - 98.4"



Free pole frame, powder coated aluminium.  
Canopy is weatherproof and colour resistant.  
Diameter of the pole:  $\varnothing$  38 mm, 1.5".

MALIBU



max. 17 km/h, 10.6 mph

**MALIBU** fully assembled (excl. base)

**UMMAL FRAME & CANOPY**

		<b>A01C002</b> white & white
		<b>A01C105</b> white & light grey
		<b>A01C418</b> white & ocean
		<b>A01C421</b> white & kiwi
		<b>A12C002</b> alu teak & white*
		<b>A12C109</b> alu teak & speckle*
		<b>A30C002</b> anthracite & white
		<b>A30C105</b> anthracite & light grey
		<b>A30C109</b> anthracite & speckle
		<b>A30C200</b> anthracite & dark grey
		<b>A30C302</b> anthracite & mocca
		<b>A30C405</b> anthracite & orange
		<b>A30C407</b> anthracite & red
		<b>A32C209</b> black & coal

\*Only available in  $\varnothing$  300 cm, 250 x 200 cm, 240 x 240 cm.

**UB BASE**

	<b>LON-35</b> london
	<b>MIB37NAP-1B</b> napoli <b>NEW</b>
OPTIONAL	<b>UANAP-WHE35</b> napoli wheels <b>NEW</b>
	<b>CHI-50</b> chicago
	<b>LUC-25-B01</b> / -B30 lucca half
	<b>LUC-35-B01</b> / -B30 lucca light
OPTIONAL	<b>UALUC-WHE.35</b> lucca light wheels
	<b>ELB-28-S01</b> / -S31 elba light

**IGB-MP-SMALL** in ground base

**UP COVER**

**UMB-S-X75** grey

**UA ACCESSORIES**

**LUN-LED02** Luna LED light

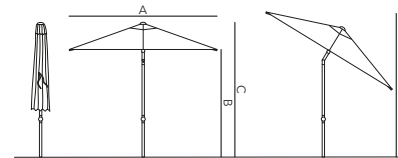
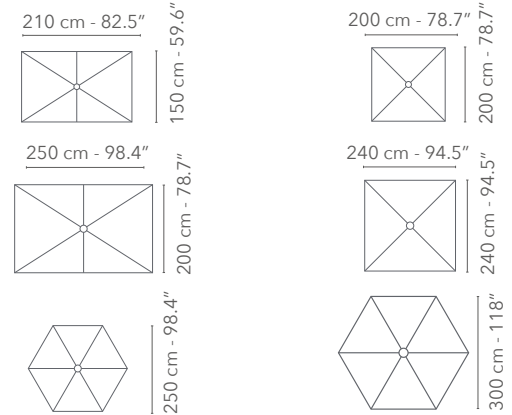

	210 X 150 CM	200 X 200 CM	$\varnothing$ 250 CM
	5 kg - 11 lbs nett excl. base	6 kg - 13.2 lbs nett excl. base	5.5 kg - 12.1 lbs nett excl. base
A	210 cm - 82.7"	200 cm - 78.7"	250 cm - 98.4"
B	195 cm - 76.8"	195 cm - 76.8"	195 cm - 76.8"
C	255 cm - 100.4"	255 cm - 100.4"	255 cm - 100.4"
D	245 cm - 96.5"	253 cm - 99.6"	255 cm - 100.4"

	250 X 200 CM	240 X 240 CM	$\varnothing$ 300 CM
	6 kg - 13.2 lbs nett excl. base	7 kg - 15.4 lbs nett excl. base	7.2 kg - 15.9 lbs nett excl. base
A	250 cm - 98.4"	240 cm - 94.5"	300 cm - 118.1"
B	195 cm - 76.8"	195 cm - 76.8"	195 cm - 76.8"
C	255 cm - 100.4"	255 cm - 100.4"	255 cm - 100.4"
D	255 cm - 100.4"	260 cm - 102.4"	275 cm - 108.3"



# CUBA

Mid pole frame, eucalyptus wood.  
Canopy is weatherproof and colour resistant.  
Diameter of the pole:  $\varnothing$  61 mm, 2.4".

















## CUBA

max. 39 km/h, 24.2 mph

### UFCUB FRAME

	<b>W60</b> eucalyptus
---	-----------------------

### UCCUB CANOPY

	<b>C002</b> white		<b>C105</b> light grey
	<b>C001</b> natural		<b>C101</b> cloud
	<b>C106</b> gris nature		<b>C204</b> night
	<b>C208</b> black		<b>C301</b> taupe
	<b>C010</b> latte		<b>C211</b> steel
	<b>C304</b> walnut		<b>C212</b> gasoline <b>NEW</b>
	<b>C402</b> tangerine		<b>C409</b> brick
	<b>C417</b> jeans		<b>C424</b> spinach

**Free pick:** other fabrics on demand

### UB BASE

		<b>ELB-84-S01 / -S31</b> elba heavy
---	---	-------------------------------------

**IGB-MP-LARGE** in ground base

**FFP-MP-LARGE** on ground base

### UP COVER

<b>CUB-M</b>
--------------

300 cm - 118.1"

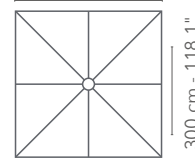

300 cm - 118.1"

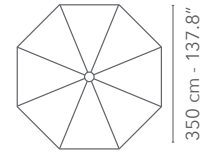

350 cm - 137.8"

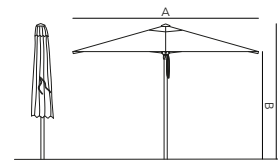

	300 X 300 CM	Ø 350 CM
	22 kg - 48.5 lbs nett excl. base	22 kg - 48.5 lbs nett excl. base
A	300 cm - 118.1"	350 cm - 137.8"
B	265 cm - 104.3"	234 cm - 92.1"
C	300 cm - 118.1"	365 cm - 143.7"



300 x 300 cm



Ø 350 cm

Mid pole frame, teak scratched.  
 Canopy is weatherproof and colour resistant.  
 Diameter of the pole: ø 61 mm, 2.4".

# MOOREA



















max. 39 km/h, 24.2 mph

## MOOREA

### UFMOO FRAME

	<b>W63</b> teak scratched
---	---------------------------

### UCCUB CANOPY

	<b>C002</b> white		<b>C105</b> light grey
	<b>C001</b> natural		<b>C101</b> cloud
	<b>C106</b> gris nature		<b>C204</b> night
	<b>C208</b> black		<b>C301</b> taupe
	<b>C010</b> latte		<b>C211</b> steel
	<b>C304</b> walnut		<b>C212</b> gasoline <b>NEW</b>
	<b>C402</b> tangerine		<b>C409</b> brick
	<b>C417</b> jeans		<b>C424</b> spinach

**Free pick:** other fabrics on demand

### UB BASE

		<b>ELB-84-S01 / -S31</b> elba heavy
---	---	-------------------------------------

**IGB-MP-LARGE** in ground base

**FFP-MP-LARGE** on ground base

### UP COVER

<b>CUB-M</b>
--------------

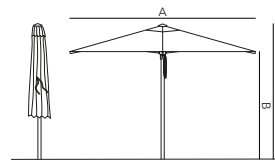
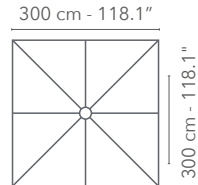

	300 X 300 CM
	28 kg - 61.7 lbs nett excl. base
A	300 cm - 118.1"
B	238 cm - 93.7"
C	272 cm - 107.1"





300 x 300 cm

# BASES

## UBAZO-125CA - SILK GREY GRANITE Azore

	125 kg, 275.6 lbs 80 x 80 x 5.5 cm, 31.5 x 31.5 x 2.2"
	<b>G04</b> light grey granite, bush hammered  wheels included

## UBANT-125 - CONCRETE Antego

 	125 kg, 275.6 lbs 92.5 x 92.5 x 5 cm, 36.4 x 36.4 x 2"
	<b>B03</b> linen, <b>B32</b> black concrete  wheels included

## UBANT-125CA - SILK GREY GRANITE Antego

	125 kg, 275.6 lbs 92.5 x 92.5 x 5 cm, 36.4 x 36.4 x 2"
	<b>G04</b> light grey granite, bush hammered  wheels included
	<b>UBANT-EW60-G04</b> 2 half tiles 2x 30 kg, 2x 66 lbs

## UBANT-125 - SANDSTONE Antego

	125 kg, 275.6 lbs 92.5 x 92.5 x 5 cm, 36.4 x 36.4 x 2"
	<b>G13</b> Egyptian sandstone with sandblasted finish  wheels included

## UBANT-125 - BLACK GRANITE Antego

	125 kg, 275.6 lbs 92.5 x 92.5 x 5 cm, 36.4 x 36.4 x 2"
	<b>G32</b> black granite, bush hammered  wheels included

## UBLON-35 - LONDON Malibu

	35 kg, 77.2 lbs ø 50 cm, 19.7" tube: ø 58 mm, 2.3"
	<b>B32</b> black concrete  wheels included

## MIB37NAP-1B - NAPOLI Malibu

	37 kg, 81.6 lbs 50 x 50 x 3 cm, 19.7 x 19.7 x 1.2" adaptor rings: ø 35, 38, 48 mm - 13.8, 14.8, 18.9"
	<b>B32</b> black concrete
	<b>UANAP-WHE35</b> Set of 4 wheels 4x ø 50 cm, 19.7"

## UBCHI-50 - CHICAGO Malibu

	50 kg, 110.2 lbs ø 50 cm, 19.7" tube: ø 58 mm, 2.3"
	<b>B32</b> black concrete  wheels included

## UBKIN-300 KINGSTON - LIMA

	300 kg, 661.4 lbs 100 x 100 x 10 cm, 39.4 x 39.4 x 4" tube: ø 45 mm, 1.7"
	<b>G04</b> light grey granite, bush hammered  wheels included

## UBELB-28 - ELBA LIGHT Malibu

	28 kg, 63.9 lbs 49 x 49 x 1.6 cm, 19.3 x 19.3 x 0.6" tube: ø 45 mm, 1.8"
	<b>S01</b> white, <b>S31</b> charcoal metallised & powder coated steel  wheels included



## UBELB-44 - ELBA MEDIUM Amalfi

	<p>44 kg, 97 lbs 54.5 x 54.5 x 1.8 cm, 21.5 x 21.5 x 0.7" tube: ø 55 mm, 2.2" adaptor ring: ø 40 mm, 1.6"</p> <p><b>S01</b> white, <b>S03</b> linen, <b>S31</b> charcoal metallised &amp; powder coated steel</p> <p>wheels included</p>
---	--



## UBELB-84 - ELBA HEAVY Cuba, Moorea

	<p>84 kg, 185.2 lbs 75.5 x 75.5 x 1.8 cm 29.7 x 29.7 x 0.7" tube: ø 65 mm, 2.6"</p> <p><b>S01</b> white, <b>S31</b> charcoal metallised &amp; powder coated steel</p> <p>wheels included</p>
---	--



## UBLUC-25 - LUCCA HALF Malibu

	<p>25 kg, 55.1 lbs 51 x 29 x 8 cm, 20 x 7 x 3.1" tube: ø 25 - 44 mm, 1 - 1.7" with quick release system adaptor rings incl.: ø 27 mm - 33 mm, ø 1.1" - 1.3"</p> <p><b>B01</b> white, <b>B30</b> anthracite concrete</p>
--	---

## UBLUC-35 - LUCCA LIGHT Malibu

	<p>35 kg, 77.2 lbs 45 x 45 x 8.5 cm, 17.7 x 17.7 x 3.3" tube: ø 25 - 44 mm, 1 - 1.7" with quick release system adaptor rings incl.: ø 27 mm - 33 mm, ø 1.1" - 1.3"</p> <p><b>B01</b> white, <b>B30</b> anthracite concrete</p>
	<p><b>UALUC-WHE.35</b> Set of 4 wheels 4x ø 50 cm, 19.7"</p>

## UBLUC-60 - LUCCA HEAVY Amalfi

	<p>60 kg, 132.3 lbs 59 x 59 x 8 cm, 23.2 x 23.2 x 3.1" tube: ø 25 - 55 mm, 1 - 2.2" with quick release system adaptor rings incl.: ø 27 mm - 33 mm - 45 mm ø 1.1" - 1.3" - 1.8"</p> <p><b>B01</b> white, <b>B30</b> anthracite concrete</p>
	<p><b>UALUC-WHE.60</b> Set of 4 wheels 4x ø 50 cm, 19.7"</p>

## IN GROUND BASE

### UBIGB-MP-SMALL Malibu, Amalfi

	<p>1 kg, 2.2 lbs ø 7 x 72 cm, 2.8 x 28" anodised aluminium</p>
--	--

### UBIGB-MP-LARGE Cuba, Moorea

	<p>15 kg, 33 lbs ø 7 x 67 cm, 2.8 x 26.4" steel</p>
--	---

### UBIGB-AZO-4G-MEDIUM Azore

	<p>5.7 kg, 12.6 lbs ø 21.5 x 51 cm, 8.5 x 20.1" steel</p>
--	---

### UBIGB-FP-5G-MEDIUM Antego

	<p>5.7 kg, 12.6 lbs ø 21.5 x 51 cm, 8.5 x 20.1" steel</p>
--	---

### UBIGB-FP-LARGE Kingston, Lima

	<p>8.4 kg, 18.5 lbs ø 25 x 51 cm, 9.8 x 20.1" steel</p>
--	---

## ON GROUND BASE

### UBOGB-MP-LARGE Cuba, Moorea

	<p>8.4 kg, 18.5 lbs 30 x 30 x 44 cm, 11.8 x 11.8 x 17.3" anodised aluminium</p>
--	---

### UBOGB-AZO-4G-MEDIUM Azore

	<p>8 kg, 17.6 lbs ø 21.5 x 2.1 cm, 8.5 x 0.5" steel</p>
--	---

### UBOGB-FP-5G-MEDIUM Antego

	<p>8 kg, 17.6 lbs ø 21.5 x 2.1 cm, 8.5 x 0.5" steel</p>
--	---

### UBOGB-FP-LARGE Kingston, Lima



	<p>8 kg, 17.6 lbs ø 21.5 x 1.2 cm, 8.5 x 0.5" steel</p>
--	---

NOA

NEW - Designed by Enrique Marti

Teak frame with hand woven strap.  
 Seat with teak.  
 Cushions are weatherproof and colour resistant.  
 Table top in solid teak.

**DINING CHAIR**



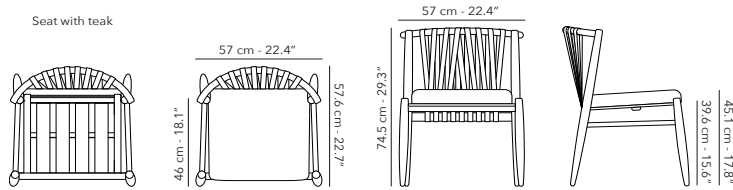

	<b>FUNOANC08</b> frame		<b>W62R11</b> teak & artichoke
	<b>CUNOAD(N)AC08</b> cushions	 	<b>C015</b> brûlé cat. B <b>C111</b> truffe cat. B

 6.8 kg  
15 lbs

Other fabrics upon request.  
 Find an overview on p. 225  
 Protection cover available.



**DINING ARMCHAIR**

	<b>FUNOAAC08</b> frame		<b>W62R11</b> teak & artichoke
	<b>CUNOAD(N)AC08</b> cushions	 	<b>C015</b> brûlé cat. B <b>C111</b> truffe cat. B

 7.7 kg  
17 lbs

Other fabrics upon request.  
 Find an overview on p. 225  
 Protection cover available.

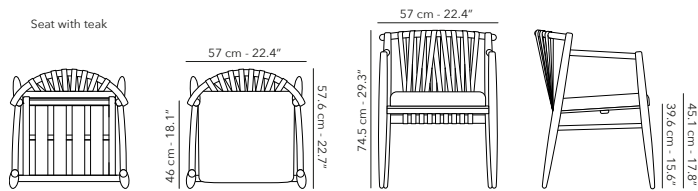

**DINING TABLE** 200 x 100 cm



	<p><b>FUNOADT43</b> frame</p>		<p><b>W62</b> teak</p>
---	-----------------------------------	---	------------------------

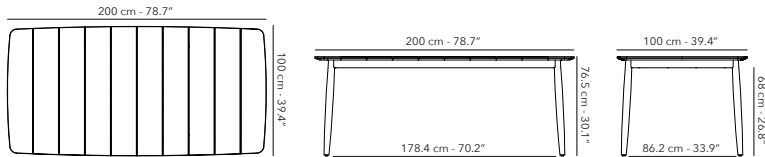

Protection cover available.



**DINING TABLE** 270 x 100 cm



	<p><b>FUNOADT46</b> frame</p>		<p><b>W62</b> teak</p>
--	-----------------------------------	--	------------------------

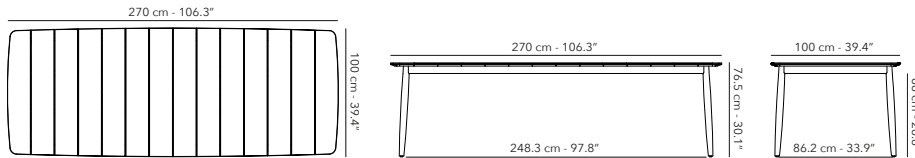

Protection cover available.



**DINING TABLE** 340 x 100 cm

	<p><b>FUNOADT50</b> frame</p>		<p><b>W62</b> teak</p>
---	-----------------------------------	---	------------------------



Protection cover available.

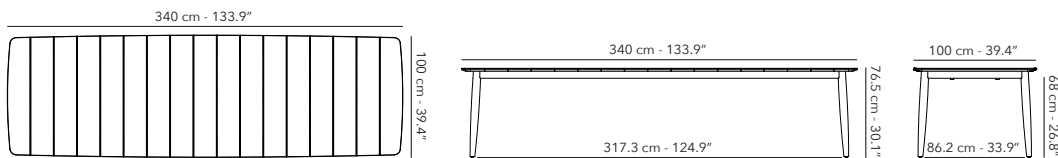





# NOA

## NEW - Designed by Enrique Marti

Teak frame with hand woven strap.  
 Seat with teak.  
 Cushions are weatherproof and colour resistant.  
 Table top in solid teak.

### LOUNGE CHAIR 1S



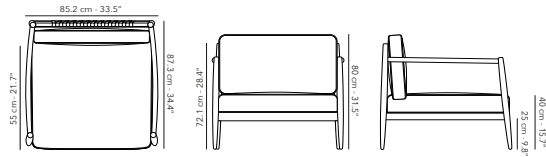

	FUNOA1S06 frame		W62R11 teak & artichoke
	CUNOA1S06 cushions		C015 brûlé cat. B
			C111 truffe cat. B

 20.2 kg  
44.5 lbs

Other fabrics upon request.  
 Find an overview on p. 225  
 Protection cover available.



### SOFA 2S



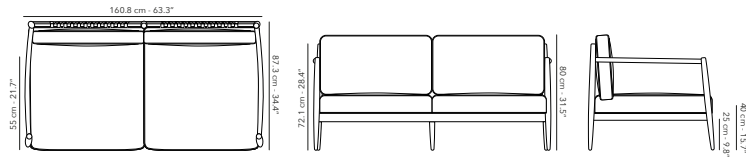

	FUNOA2S06 frame		W62R11 teak & artichoke
	2x CUNOA1S06 cushions		C015 brûlé cat. B
			C111 truffe cat. B

 36.4 kg  
80.3 lbs

Other fabrics upon request.  
 Find an overview on p. 225  
 Protection cover available.



### SOFA 3S

	FUNOA3S06 frame		W62R11 teak & artichoke
	3x CUNOA1S06 cushions		C015 brûlé cat. B
			C111 truffe cat. B

 53.7 kg  
118.4 lbs

Other fabrics upon request.  
 Find an overview on p. 225  
 Protection cover available.

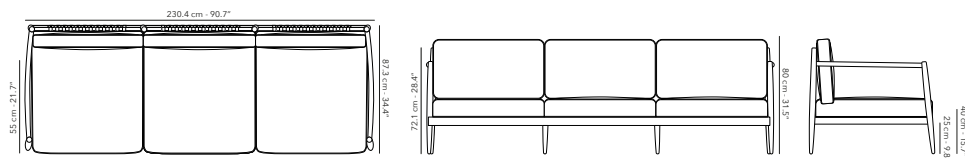

**COFFEE TABLE** 125 x 75 cm



**FUNOALT10**  
frame



**W62** teak



23.5 kg  
51.8 lbs

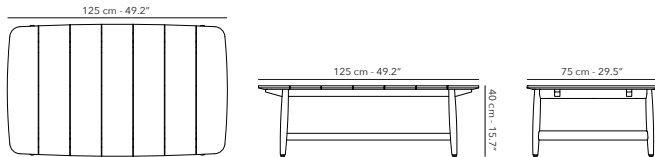

**SIDE TABLE** 50 x 50 cm



**FUNOAST08**  
frame



**W62** teak



6.4 kg  
14.1 lbs

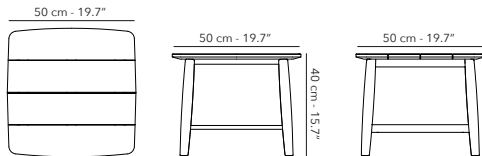

**SOFA SIDE TABLE**



**FUNOASST01**  
frame



**W62** teak



4.3 kg  
9.5 lbs

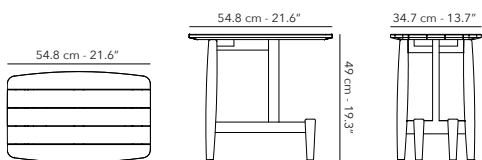





NOA

NEW - Designed by Enrique Marti

Teak frame with hand woven strap.  
 Seat with teak.  
 Cushions are weatherproof and colour resistant.  
 Table top in solid teak.



**SUNLOUNGER**

	FUNOASL06 frame		W62 teak	28.8 kg 63.5 lbs
	CUNOASL06 cushions		C015 brûlé cat. B	
			C111 truffe cat. B	

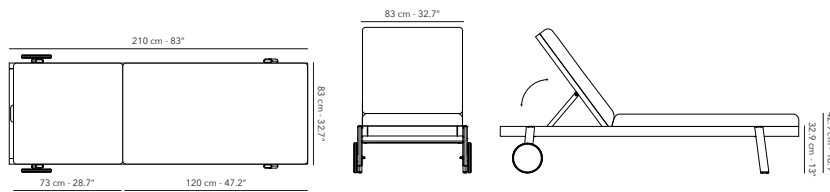
Other fabrics upon request.  
 Find an overview on p. 225  
 Protection cover available.



**DIVIDER** H150 cm - H180 cm



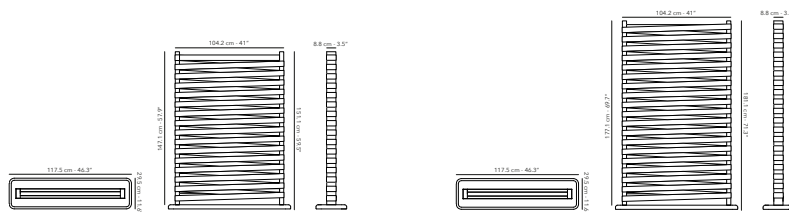

	FUNOADIV150 frame low		W62R11 teak & artichoke	Low: 24 kg 52.9 lbs	High: 24 kg 52.9 lbs
	FUNOADIV180 frame high		W62R11 teak & artichoke		



Black teak frame with hand woven rope.  
 Cushions are weatherproof and colour resistant.  
 Table top in solid teak.  
 Corrector available to touch-up teak.

NERO  
 NEW

**DINING ARMCHAIR**



	<b>FUNERAC09</b> frame		<b>W68R13</b> black teak & sand
	<b>CUNERAC09</b> cushions		<b>C015</b> brûlé cat. B
			<b>C111</b> truffe cat. B

 7 kg  
15.4 lbs

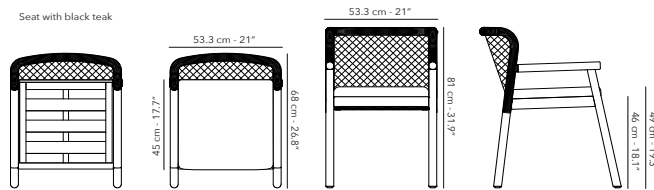
Other fabrics upon request.  
 Find an overview on p. 225  
 Protection cover available.





**DINING TABLE 240 x 100 cm**

	<b>FUNERDT44</b> frame		<b>W68</b> black teak
--	---------------------------	--	-----------------------

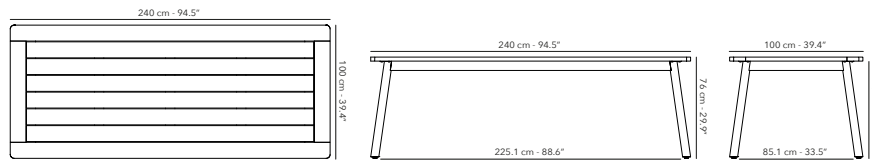
 68 kg  
150 lbs



**DINING TABLE 300 x 100 cm**

	<b>FUNERDT47</b> frame		<b>W68</b> black teak
---	---------------------------	---	-----------------------



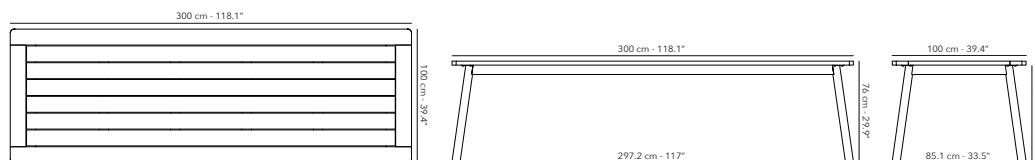

 80 kg  
176.4 lbs



# NERO

Black teak frame with hand woven rope.  
 Cushions are weatherproof and colour resistant.  
 Table top in solid teak.  
 Corrector available to touch-up teak.

## LOUNGE CHAIR 1S



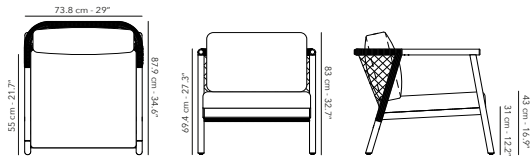

	<b>FUNER1S07</b> frame		<b>W68R13</b> black teak & sand
	<b>CUNER1S07</b> cushions	 	<b>C015</b> brûlé cat. B <b>C111</b> truffe cat. B

 15.1 kg  
33.3 lbs

Other fabrics upon request.  
 Find an overview on p. 225  
 Protection cover available.



## SOFA 2S



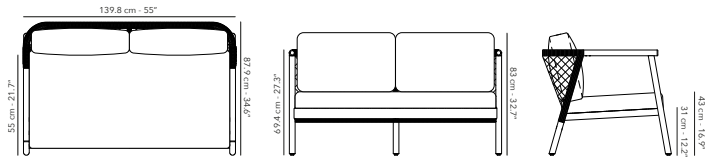

	<b>FUNER2S07</b> frame		<b>W68R13</b> black teak & sand
	<b>CUNER2S07</b> cushions	 	<b>C015</b> brûlé cat. B <b>C111</b> truffe cat. B

 26.5 kg  
58.4 lbs

Other fabrics upon request.  
 Find an overview on p. 225  
 Protection cover available.



## SOFA 3S

	<b>FUNER3S07</b> frame		<b>W68R13</b> black teak & sand
	<b>CUNER3S07</b> cushions	 	<b>C015</b> brûlé cat. B <b>C111</b> truffe cat. B

 37.7 kg  
83.1 lbs

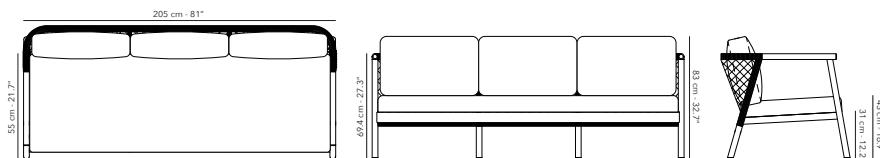

Other fabrics upon request.  
 Find an overview on p. 225  
 Protection cover available.





# NERO



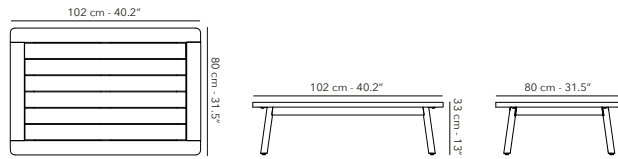

## COFFEE TABLE 120 x 80 cm

	<b>FUNERLT10</b> frame		<b>W68</b> black teak
---	---------------------------	---	-----------------------

19.5 kg  
43 lbs



## SUNLOUNGER

	<b>FUNERSL07</b> frame		<b>W68R13</b> black teak & sand
	<b>CUNERSL07</b> cushions		<b>C015</b> brûlé cat. B
			<b>C111</b> truffe cat. B



35 kg  
77.2 lbs

Other fabrics upon request.  
Find an overview on p. 225  
Protection cover available.

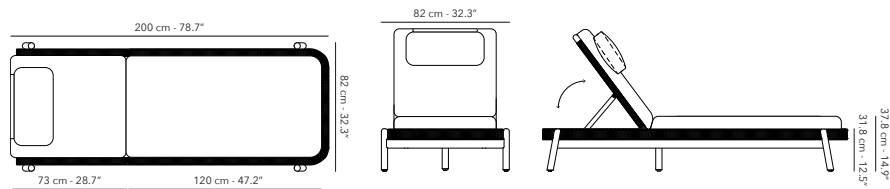





# TUGU

## UPDATED

Aluminium frame with hand woven wicker 6 mm.  
 Seat with Essegomma strap 50 mm or (sable) teak.  
 Table top is made of (sable) solid teak or ceramic 12 mm.



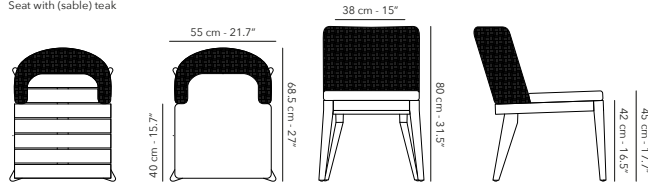

### DINING CHAIR

	<b>FUTUGNC01</b> frame	 <b>F16W62</b> cottage & teak	<b>9.7 kg</b> <b>21.4 lbs</b>
	<b>CUTUGNC01</b> cushions	 <b>F16W64</b> cottage & sable teak	
		 <b>C008</b> linen cat. A	Other fabrics upon request. Find an overview on p. 225 Protection cover available.

Seat with (sable) teak



### DINING ARMCHAIR

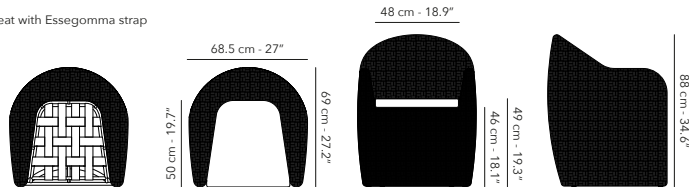

	<b>FUTUGAC05</b> frame	 <b>F16</b> cottage	 <b>14.8 kg</b> <b>32.6 lbs</b>
	<b>CUTUGAC05</b> cushions	 <b>C008</b> linen cat. A	
			Other fabrics upon request. Find an overview on p. 225 Protection cover available.

Seat with Essegomma strap



# TUGU

## SOFA 1S

	<b>FUTUG1S03</b> frame		<b>F16 cottage</b>
	<b>CUTUG1S03</b> cushions		<b>C008 linen cat. A</b>





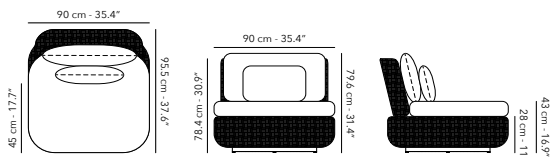

 30 kg  
66 lbs

Other fabrics upon request.  
 Find an overview on p. 225  
 Protection cover available.  
 360° rotation through the swivel system.



## SOFA 2S

	<b>FUTUG2S03</b> frame		<b>F16 cottage</b>
	<b>CUTUG2S03</b> cushions		<b>C008 linen cat. A</b>



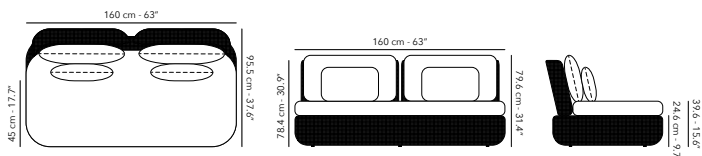

 41.5 kg  
91.5 lbs

Other fabrics upon request.  
 Find an overview on p. 225  
 Protection cover available.



## SOFA 3S

	<b>FUTUG3S03</b> frame		<b>F16 cottage</b>
	<b>CUTUG3S03</b> cushions		<b>C008 linen cat. A</b>



 60 kg  
132.3 lbs

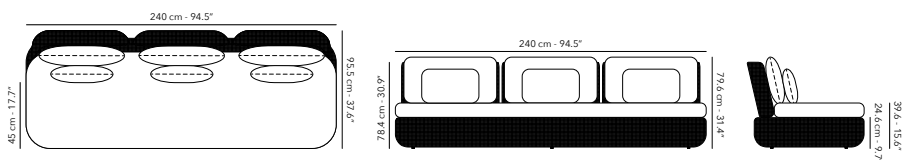

Other fabrics upon request.  
 Find an overview on p. 225  
 Protection cover available.



# TUGU

Aluminium frame with hand woven wicker 6 mm.  
 Seat with Essegomma strap 50 mm or (sable) teak.  
 Table top is made of (sable) solid teak or ceramic 12 mm.

## OTTOMAN 90 x 90 cm



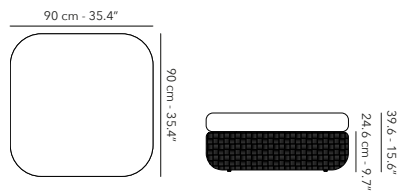

	<b>FUTUGOT01</b> frame		<b>F16</b> cottage
	<b>CUTUGOT01</b> cushions		<b>C008</b> linen cat. A

 13.7 kg  
30.2 lbs

Other fabrics upon request.  
 Find an overview on p. 225  
 Protection cover available.





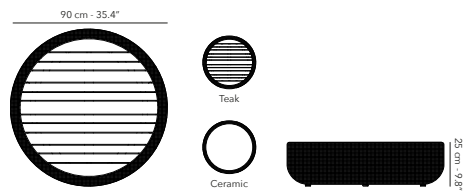

## COFFEE TABLE ø 90 cm

	<b>FUTUGLT08S</b> frame		<b>F16</b> cottage
	<b>FUTUGTOP04</b> table top		<b>W62</b> teak <b>NEW</b>
			<b>W64</b> sable teak
			<b>K14</b> taupegrey

 13 kg  
28.6 lbs





## COFFEE TABLE ø 120 cm

	<b>FUTUGLT07S</b> frame		<b>F16</b> cottage
	<b>FUTUGTOP06</b> table top		<b>W62</b> teak <b>NEW</b>
			<b>W64</b> sable teak
			<b>K14</b> taupegrey

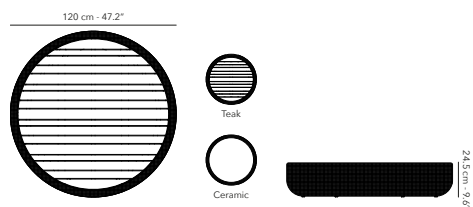
 19 kg  
42 lbs



## SUNLOUNGER



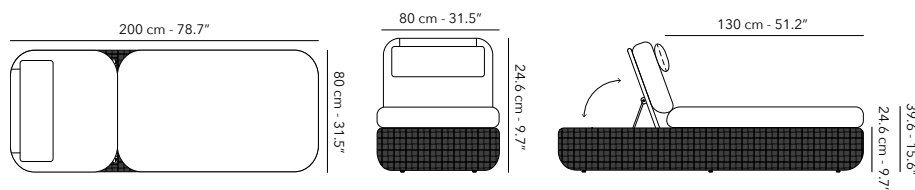

	<b>FUTUGSL02</b> frame		<b>F16</b> cottage
	<b>CUTUGSL02</b> cushions		<b>C008</b> linen cat. A

 30 kg  
66 lbs

Other fabrics upon request.  
Find an overview on p. 225  
Protection cover available.



## SIDE TABLE ø 45 cm

	<b>FUTUGST05S</b> frame		<b>F16</b> cottage
	<b>FUTUGTOP05</b> table top		<b>W62</b> teak <b>NEW</b>
			<b>W64</b> sable teak
			<b>K14</b> taupegrey

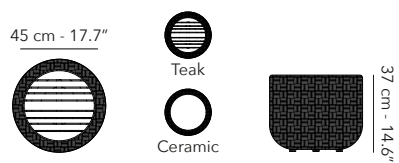

 5.3 kg  
11.6 lbs



# LEGNA

Sable teak frame with hand woven rope 10 mm.  
 Cushions are weatherproof and colour resistant.  
 Table top is made of ceramic 12 mm.  
 Corrector available to touch-up teak.

## DINING ARMCHAIR



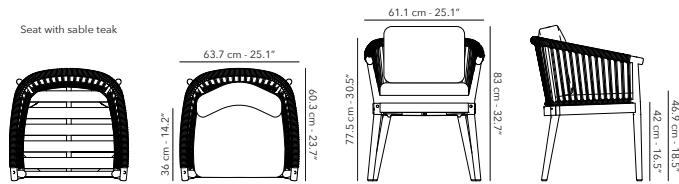

	<b>FULEGAC06</b> frame		<b>W64R12</b> sable teak & cream
	<b>CULEGAC06</b> cushions		<b>C012</b> cream cat. B

9.2 kg  
20.3 lbs

Other fabrics upon request.  
 Find an overview on p. 225  
 Protection cover available.





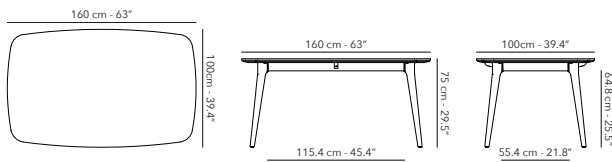

## DINING TABLE 160 x 100 cm

	<b>FULEGDT41S</b> frame		<b>W64</b> sable teak
	<b>FULEGTOP41</b> table top		<b>K14</b> taupegrey
			<b>K01</b> white
			<b>K31</b> charcoal





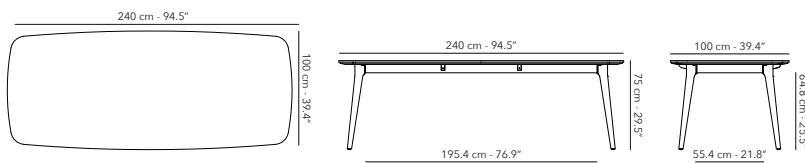

## DINING TABLE 240 x 100 cm

	<b>FULEGDT44S</b> frame		<b>W64</b> sable teak
	<b>FULEGTOP44</b> table top		<b>K14</b> taupegrey
			<b>K01</b> white
			<b>K31</b> charcoal



## DINING TABLE 320 x 100 cm



	<b>FULEGDT49S</b> frame		<b>W64</b> sable teak
	<b>FULEGTOP49</b> table top		<b>K14</b> taupegrey
			<b>K01</b> white
			<b>K31</b> charcoal



# LEGNA

Sable teak frame with hand woven rope 10 mm.  
Cushions are weatherproof and colour resistant.  
Table top is made of ceramic 12 mm.  
Corrector available to touch-up teak.

## LOUNGE CHAIR 1S

	<b>FULEG1S04</b> frame		<b>W64R12</b> sable teak & cream
	<b>CULEG1S04</b> cushions		<b>C012</b> cream cat. B



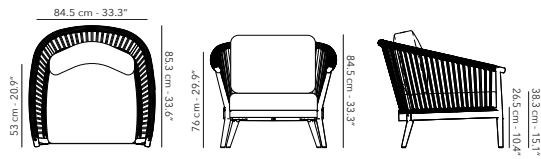

14 kg  
31 lbs

Other fabrics upon request.  
Find an overview on p. 225  
Protection cover available.



## SOFA 2.5S

	<b>FULEG2S04</b> frame		<b>W64R12</b> sable teak & cream
	<b>CULEG2S04</b> cushions		<b>C012</b> cream cat. B



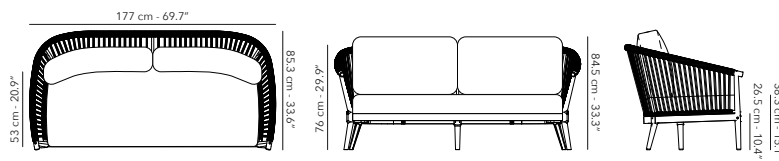

28.6 kg  
63 lbs

Other fabrics upon request.  
Find an overview on p. 225  
Protection cover available.



## SOFA 3S

	<b>FULEG3S04</b> frame		<b>W64R12</b> sable teak & cream
	<b>CULEG3S04</b> cushions		<b>C012</b> cream cat. B



33.5 kg  
74 lbs

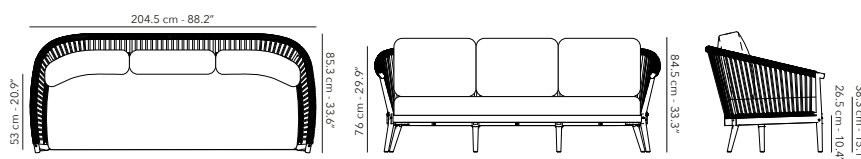

Other fabrics upon request.  
Find an overview on p. 225  
Protection cover available.





# LEGNA



## CHAISE LONGUE

	<b>FULEGCL03</b> frame	 <b>W64R12</b> sable teak & cream	25.6 kg 56.4 lbs
	<b>CULEGCL03</b> cushions	 <b>C012</b> cream cat. B	

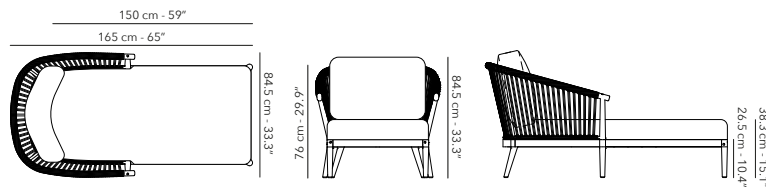
Other fabrics upon request.  
Find an overview on p. 225  
Protection cover available.



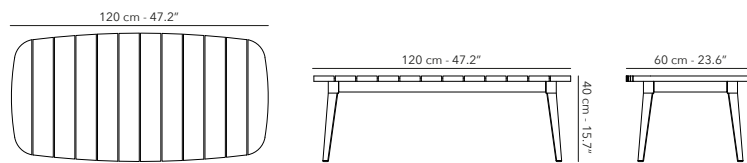

## COFFEE TABLE 120 x 60 cm

	<b>FULEGLT09</b> frame	 <b>W64</b> sable teak	13.5 kg 29.8 lbs
--	---------------------------	--	---------------------



## SIDE TABLE 50 x 35 cm

	<b>FULEGST07</b> frame	 <b>W64</b> sable teak	4 kg 8.8 lbs
---	---------------------------	---	-----------------

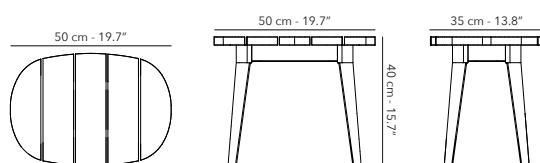

# SCOOP

UPDATED with new frame colour A01 white

Aluminium frame with hand woven rope.  
Cushions are weatherproof and colour resistant.

## LOUNGE CHAIR 1S

	FUSCO1S05 frame	<input type="checkbox"/> A01R02 white silver <b>NEW</b> <input checked="" type="checkbox"/> A14R14 lava brown	16.5 kg 36.4 lbs
	CUSCO1S05 cushions	<input checked="" type="checkbox"/> C007 beige cat. B	

Other fabrics upon request.  
Find an overview on p. 225  
Protection cover available.

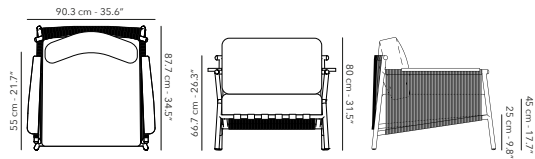

## SOFA 2S

	FUSCO2S05 frame	<input type="checkbox"/> A01R02 white silver <b>NEW</b> <input checked="" type="checkbox"/> A14R14 lava brown	28.5 kg 62.8 lbs
	CUSCO2S05 cushions	<input checked="" type="checkbox"/> C007 beige cat. B	

Other fabrics upon request.  
Find an overview on p. 225  
Protection cover available.

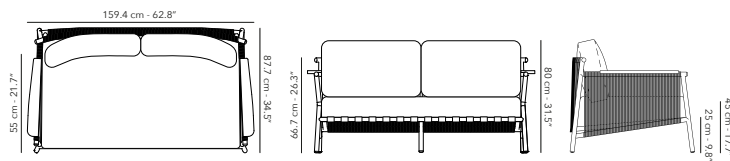

## SOFA 3S

	FUSCO3S05 frame	<input type="checkbox"/> A01R02 white silver <b>NEW</b> <input checked="" type="checkbox"/> A14R14 lava brown	42.5 kg 93.7 lbs
	CUSCO3S05 cushions	<input checked="" type="checkbox"/> C007 beige cat. B	

Other fabrics upon request.  
Find an overview on p. 225  
Protection cover available.

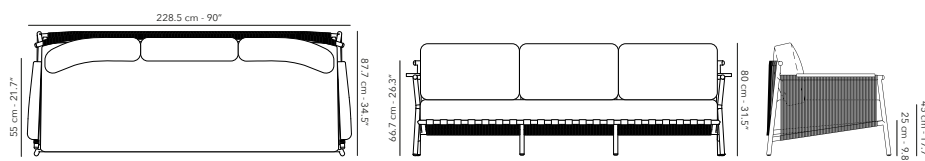

# SCOOP

## SUNLOUNGER

	FUSCOSL05 frame	<input type="checkbox"/> A01R02 white silver <b>NEW</b> <input checked="" type="checkbox"/> A14R14 lava brown	19 kg 42 lbs
	CUSCOSL05 cushions	<input checked="" type="checkbox"/> C007 beige cat. B	



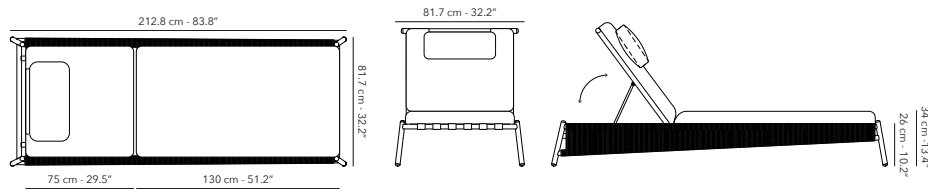

Other fabrics upon request.  
Find an overview on p. 225  
Protection cover available.



# MAUROO

Aluminium frame. Each piece has a connector.  
Cushions are weatherproof and colour resistant.

## LOUNGE CHAIR 1S

	<b>FUMAUMS02</b> frame	 <b>A01</b> white
		 <b>A31</b> charcoal
	<b>CUMAUMS02</b> cushions	 <b>C006</b> vanilla cat. B
		 <b>C202</b> smoke grey cat. B





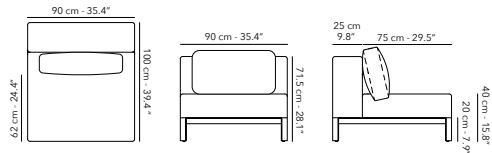

13.5 kg  
29.8 lbs

Other fabrics upon request.  
Find an overview on p. 225  
Protection cover available.



## SOFA 2S

	<b>FUMAUDS02M</b> frame	 <b>A01</b> white
		 <b>A31</b> charcoal
	<b>CUMAUDS02M</b> cushions	 <b>C006</b> vanilla cat. B
		 <b>C202</b> smoke grey cat. B





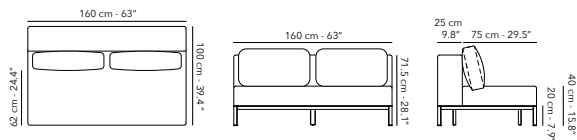

23 kg  
50.7 lbs

Other fabrics upon request.  
Find an overview on p. 225  
Protection cover available.



## LONG SOFA WITH TEAK TABLE

	<b>FUMAUDS02LRT</b> frame	 <b>A01W62</b> white & teak
		 <b>A31W62</b> charcoal & teak
	<b>CUMAUDS02LR</b> cushions	 <b>C006</b> vanilla cat. B
		 <b>C202</b> smoke grey cat. B



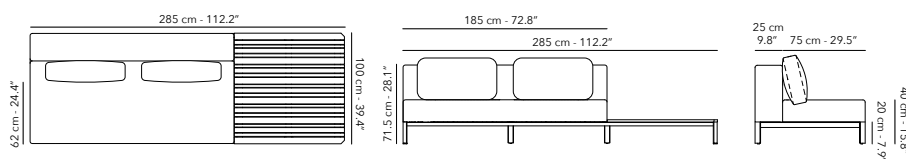

25 kg  
55.1 lbs

Other fabrics upon request.  
Find an overview on p. 225  
Protection cover available.  
The back fits on both sides.



# MAUROO

## LONG SOFA WITH TEAK TABLE & ARM



	FUMAUS02LRT FUMAUARM01 frame		A01W62 white & teak A31W62 charcoal & teak
	CUMAUS02LRA cushions		C006 vanilla cat. B C202 smoke grey cat. B

 27 kg  
59.5 lbs

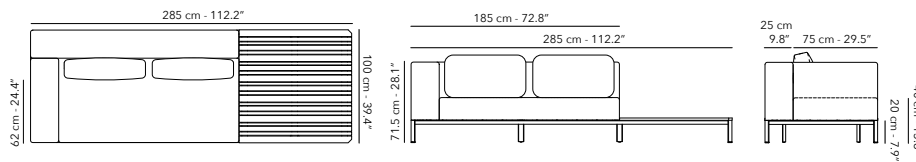
Other fabrics upon request.  
Find an overview on p. 225  
Protection cover available.  
The back fits on both sides.

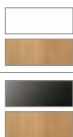

## CHAISE LONGUE



	FUMAUC02LRT frame		A01W62 white & teak A31W62 charcoal & teak
	CUMAUC02 cushions		C006 vanilla cat. B C202 smoke grey cat. B

 23 kg  
50.7 lbs

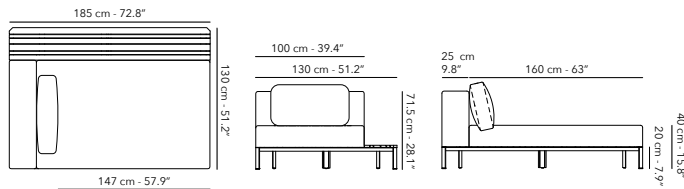
Other fabrics upon request.  
Find an overview on p. 225  
Protection cover available.  
The teak table top fits on both sides.



## COFFEE TABLE 120 x 80 cm

	FUMAULT03 frame		A01W62 white & teak A31W62 charcoal & teak
---	--------------------	---	---

 21.5 kg  
47.4 lbs

Protection cover available.

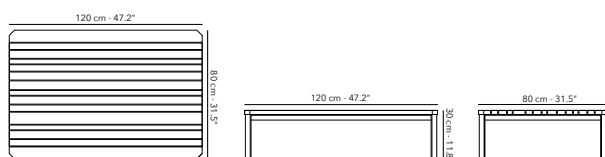





# MAUROO CONCEPT

Aluminium frame. Each piece has a connector.  
Cushions are weatherproof and colour resistant.

## CONCEPT 1

LEFT / RIGHT

frame	1x FUMAUDS02LRT 1x FUMAUDS02M 1x FUMAULT03	 A01 white
		 A31 charcoal
cushions	1x CUMAUDS02LR 1x CUMAUDS02M	 C006 vanilla cat. B
		 C202 smoke grey cat. B



Protection cover available per module.



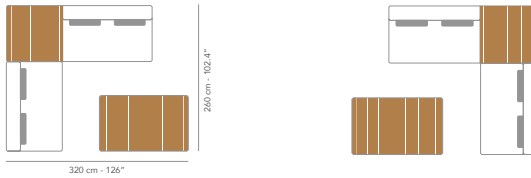

LEFT

RIGHT



## CONCEPT 2

LEFT / RIGHT

frame	1x FUMAUDS02LRT 1x FUMAUDS02M 1x FUMAUCLO2LRT 1x FUMAULT03	 A01 white
		 A31 charcoal
cushions	1x CUMAUDS02LR 1x CUMAUDS02M 1x CUMAUCLO2	 C006 vanilla cat. B
		 C202 smoke grey cat. B



Protection cover available per module.



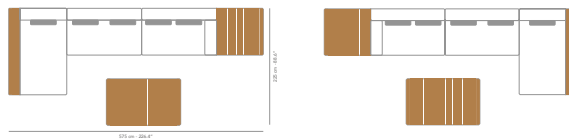

LEFT

RIGHT



## CONCEPT 3

LEFT / RIGHT

frame	2x FUMAUDS02LRT 1x FUMAARM01 1x FUMAUDS02M 1x FUMAULT03	 A01 white
		 A31 charcoal
cushions	1x CUMAUDS02LRA 1x CUMAUDS02LR 1x CUMAUDS02M	 C006 vanilla cat. B
		 C202 smoke grey cat. B



Protection cover available per module.

LEFT

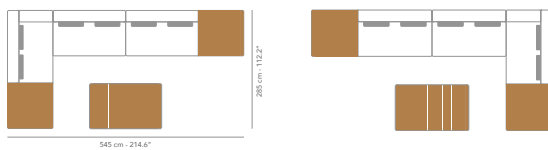

RIGHT



Solid teak frame.  
Cushions are weatherproof and colour resistant.

TECCA

**DINING TABLE** 160 x 80 cm



	<p>FUTECDT41 frame</p>		<p>W62 teak</p>
---	----------------------------	---	-----------------

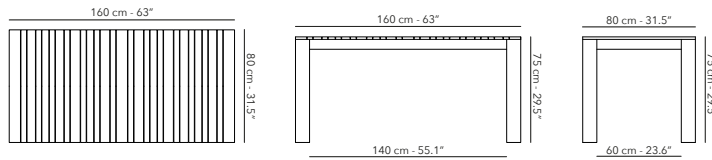

Ideal with **Tecca bench 130 x 38 cm**.  
Fits under the long sides of the table.



**DINING TABLE** 280 x 100 cm



	<p>FUTECDT46 frame</p>		<p>W62 teak</p>
--	----------------------------	--	-----------------

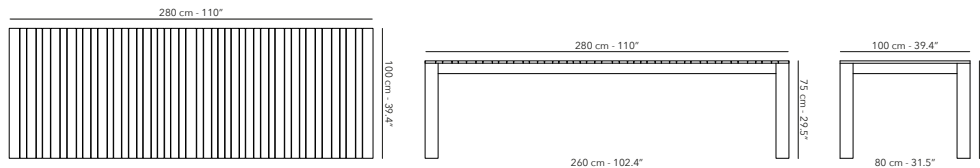

Ideal with **Tecca bench 130 x 38 cm**.  
Fits under the long sides of the table.



**DINING TABLE** 350 x 100 cm

	<p>FUTECDT48 frame</p>		<p>W62 teak</p>
---	----------------------------	---	-----------------



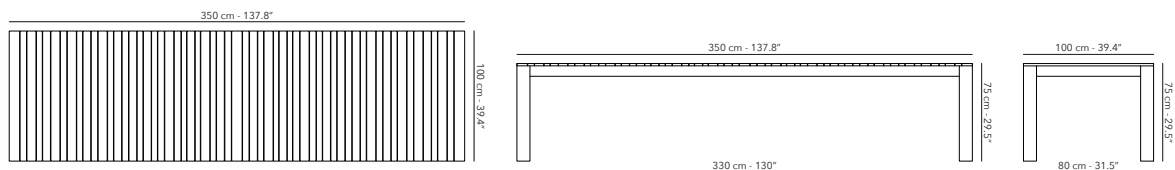

Ideal with **Tecca bench 320 x 38 cm**.  
Fits under the long sides of the table.



# TECCA

Solid teak frame.  
Cushions are weatherproof and colour resistant.

## DINING TABLE 160 x 160 cm



	<p>FUTECDT61 frame</p>		<p>W62 teak</p>
---	----------------------------	---	-----------------

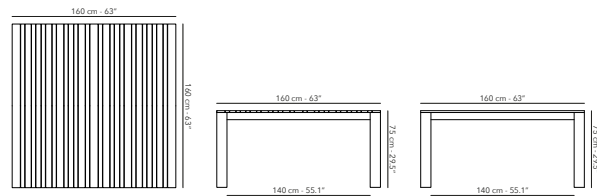

Ideal with **Tecca bench 130 x 38 cm**.  
Fits either side of the table.



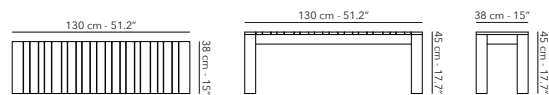

## BENCH 130 x 38 cm

	<p>FUTECBE41 frame</p>		<p>W62 teak</p>
--	----------------------------	---	-----------------



## BENCH 320 x 38 cm

	<p>FUTECBE48 frame</p>		<p>W62 teak</p>
---	----------------------------	---	-----------------

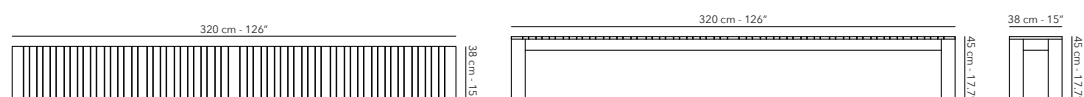







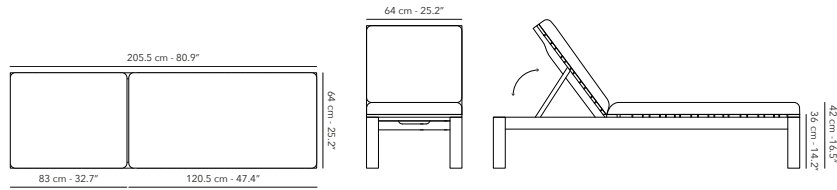

# TECCA

## SUNLOUNGER

	FUTECSL05 frame	 <b>W62 teak</b>	<p>38 kg 83.8 lbs</p> <p>Other fabrics upon request. Find an overview on p. 225 Protection cover available.</p>
	CUTECSL05 cushions	 <b>C007 beige cat. B</b>	
		 <b>C205 ebony cat. B</b>	



## YUNA DINING ARMCHAIR

	FUYUNAC07 frame	 <b>A03R03</b> linen & linen	<p>7.2 kg 16 lbs</p> <p>Other fabrics upon request. Find an overview on p. 225 Protection cover available.</p>
		 <b>A31R31</b> charcoal & charcoal	
	CUYUNAC07 cushions	 <b>C007 beige cat. B</b>	
		 <b>C205 ebony cat. B</b>	

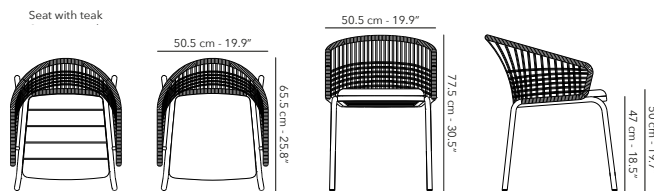

# NATURE

## UPDATED

Aluminium powder coated frame.  
Table top is made of raw teak with a thickness of 50 mm.  
No piece is the same, each table top is unique.

### LEWIS DINING ARMCHAIR







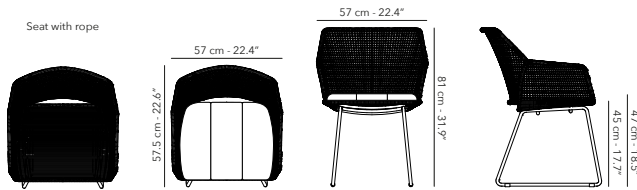

	<b>FULEWAC10</b> frame		<b>A32R32</b> black & black
	<b>CULEW(L)AC01</b> cushions		<b>C006</b> vanilla cat. B

7.5 kg  
16.5 lbs

Other fabrics upon request.  
Find an overview on p. 225  
Protection cover available.



### DINING TABLE 280 / 350 / 400 x 120 cm - 75,5 cm height

	<b>FUNATDT46S</b> frame		<b>A32</b> black
	<b>FUNATTOP46</b> table top 280 cm		<b>W62</b> teak
	<b>FUNATDT46S</b> frame		<b>A32</b> black
	<b>FUNATTOP48</b> table top 350 cm		<b>W62</b> teak
	<b>FUNATDT46S</b> frame		<b>A32</b> black
	<b>FUNATTOP51</b> table top 400 cm		<b>W62</b> teak









280 cm: 178 kg  
392.5 lbs

350 cm: 218 kg  
480.5 lbs

Same dimensions as low dining tables,  
with a height of 75.5 cm - 29.7".

### BENCH 280 cm & 350 cm - 46 cm height

	<b>FUNATBE46S</b> frame		<b>A32</b> black
	<b>FUNATTOP46B</b> seat 280 cm		<b>W62</b> teak
	<b>FUNATBE46S</b> frame		<b>A32</b> black
	<b>FUNATTOP48B</b> seat 350 cm		<b>W62</b> teak



280 cm: 178 kg  
392.5 lbs

350 cm: 218 kg  
480.5 lbs

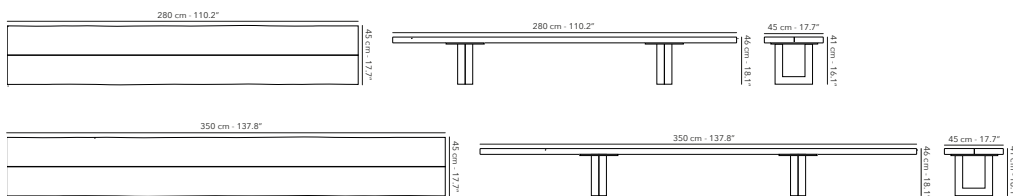

# NATURE LOW

## NEW

### LEWIS LOW DINING ARMCHAIR

	FULEWLAC01 frame	 <b>A32R32</b> black & black
	CULEW(L)AC01 cushions	 <b>C006</b> vanilla cat. B







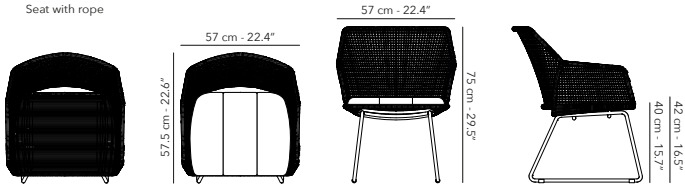

6.6 kg  
14.6 lbs

Other fabrics upon request.  
Find an overview on p. 225  
Protection cover available.

Seat with rope



### LOW DINING TABLE 280 / 350 / 400 x 120 cm - 67.5 cm height

	FUNATLDT46S frame	 <b>A32</b> black
	FUNATTOP46 table top 280 cm	 <b>W62</b> teak
	FUNATLDT46S frame	 <b>A32</b> black
	FUNATTOP48 table top 350 cm	 <b>W62</b> teak
	FUNATLDT46S frame	 <b>A32</b> black
	FUNATTOP51 table top 400 cm	 <b>W62</b> teak



280 cm: 178 kg  
392.5 lbs



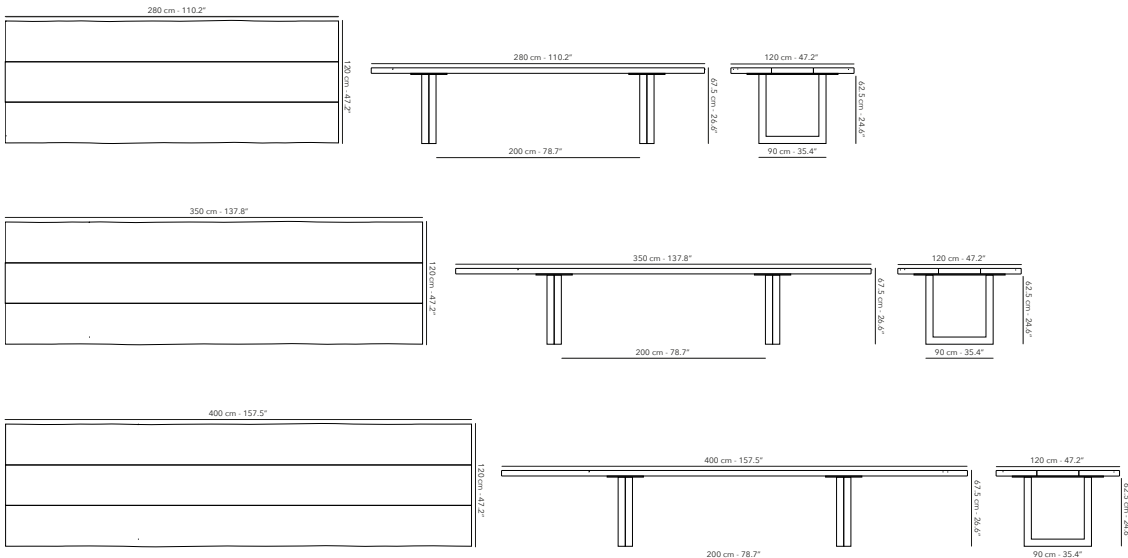

350 cm: 218 kg  
480.5 lbs



# FLEXX

Solid teak frame with anthracite 25 mm. Cushions are weatherproof and colour resistant.

## DINING ARMCHAIR



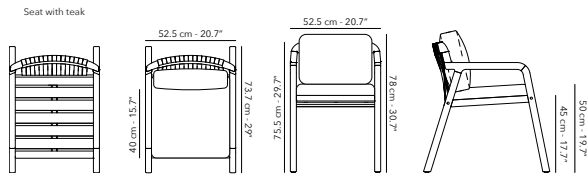

	<b>FUFLE-AC01</b> frame	 	<b>W62R30</b> teak & anthracite strap
	<b>CUFLEAC01</b> cushions		<b>C005</b> marble cat. C

 14.5 kg  
32 lbs

Other fabrics upon request.  
Find an overview on p. 225  
Protection cover available.



## BAR CHAIR



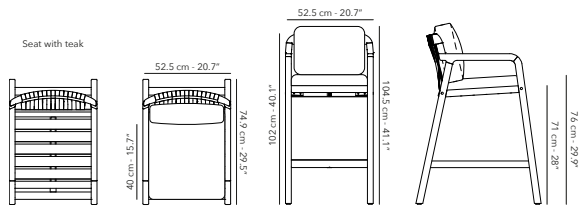

	<b>FUFLE-BC01</b> frame	 	<b>W62R30</b> teak & anthracite strap
	<b>CUFLEAC01</b> cushions		<b>C005</b> marble cat. C

 19.5 kg  
43 lbs

Other fabrics upon request.  
Find an overview on p. 225  
Protection cover available.



## COUNTER CHAIR

	<b>FUFLE-CC01</b> frame	 	<b>W62R30</b> teak & anthracite strap
	<b>CUFLEAC01</b> cushions		<b>C005</b> marble cat. C

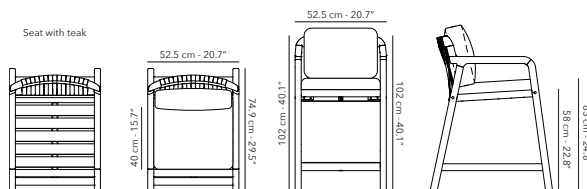

 17.5 kg  
38.6 lbs

Other fabrics upon request.  
Find an overview on p. 225  
Protection cover available.  
The back fits on both sides.



# FLEXX

## DINING TABLE 240 x 100 cm



	<b>FUFLE-DT44</b> frame		<b>W62 teak</b>
---	----------------------------	---	-----------------

 63 kg  
138.9 lbs

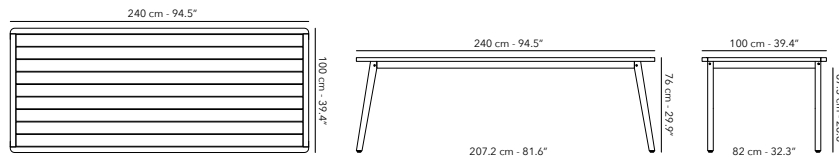
Protection cover available.



## DINING TABLE 300 x 100 cm



	<b>FUFLE-DT47</b> frame		<b>W62 teak</b>
--	----------------------------	--	-----------------

 74 kg  
163.1 lbs

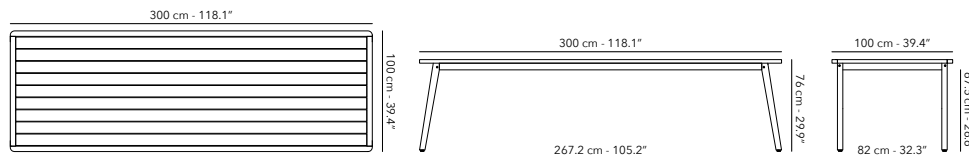
Protection cover available.



## BISTRO TABLE 80 x 80 cm

	<b>FUFLE-BI23</b> frame		<b>W62 teak</b>
---	----------------------------	---	-----------------

 26 kg  
57.3 lbs

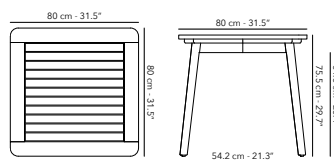

Protection cover available.



# FLEXX

Solid teak frame with anthracite 25 mm.  
Cushions are weatherproof and colour resistant.

## BAR TABLE 170 x 80 cm

	<p><b>FUFLE-BT01</b> frame</p>		<p><b>W62</b> teak</p>
---	------------------------------------	---	------------------------



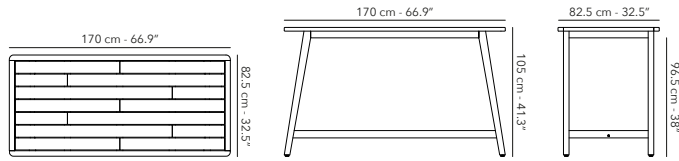

 24 kg  
52.9 lbs

Protection cover available.



## COUNTER TABLE 170 x 80 cm

	<p><b>FUFLE-CT01</b> frame</p>		<p><b>W62</b> teak</p>
--	------------------------------------	--	------------------------





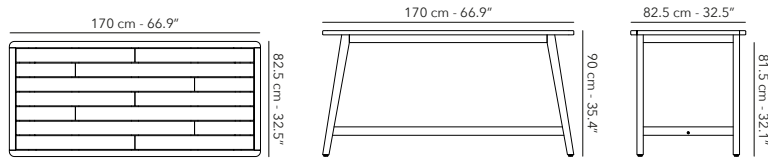

 22 kg  
48.5 lbs

Protection cover available.



## LOUNGE CHAIR 1S



	<b>FUFLE-1S01</b> frame		<b>W62R30</b> teak & anthracite strap
	<b>CUFLE1S01</b> cushions		<b>C005</b> marble cat. C

 20.5 kg  
45.2 lbs

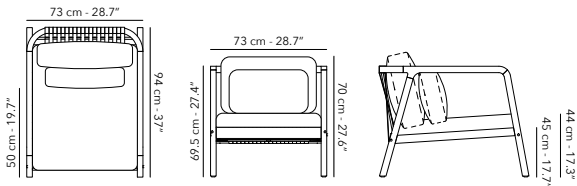
Other fabrics upon request.  
Find an overview on p. 225  
Protection cover available.



## SOFA 2S



	<b>FUFLE-2S01</b> frame		<b>W62R30</b> teak & anthracite strap
	<b>CUFLE2S01</b> cushions		<b>C005</b> marble cat. C

 32.5 kg  
71.7 lbs

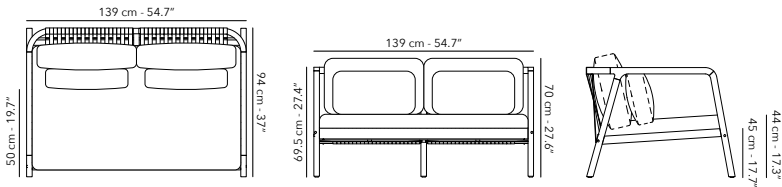
Other fabrics upon request.  
Find an overview on p.  
Protection cover available.



## SOFA 3S

	<b>FUFLE-3S01</b> frame		<b>W62R30</b> teak & anthracite strap
	<b>CUFLE3S01</b> cushions		<b>C005</b> marble cat. C

 45 kg  
99.2 lbs

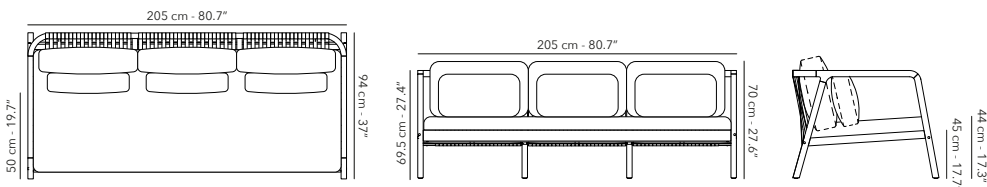

Other fabrics upon request.  
Find an overview on p. 225  
Protection cover available.  
The back fits on both sides.



# FLEXX

Solid teak frame with anthracite 25 mm. Cushions are weatherproof and colour resistant.

## COFFEE TABLE 120 x 80 cm



	<p><b>FUFLE-LT01</b> frame</p>		<p><b>W62</b> teak</p>
---	------------------------------------	---	------------------------

 26 kg  
57.3 lbs

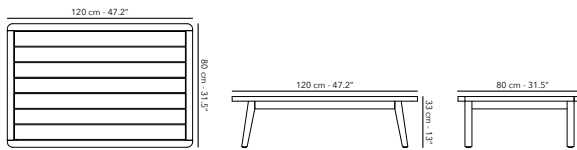
Protection cover available.



## COFFEE TABLE 120 x 120 cm



	<p><b>FUFLE-LT02</b> frame</p>		<p><b>W62</b> teak</p>
--	------------------------------------	---	------------------------

 34 kg  
75 lbs

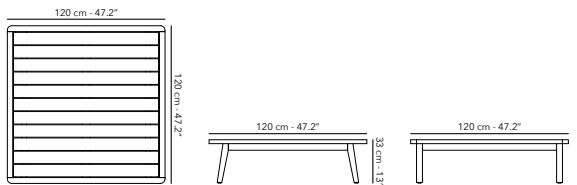
Protection cover available.



## SIDE TABLE 45 x 45 cm

	<p><b>FUFLE-ST01</b> frame</p>		<p><b>W62</b> teak</p>
---	------------------------------------	---	------------------------



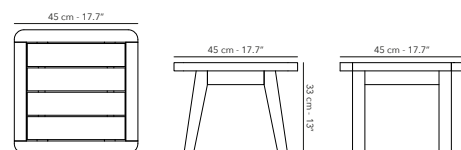

 6 kg  
13.2 lbs

Protection cover available.





## SUNLOUNGER



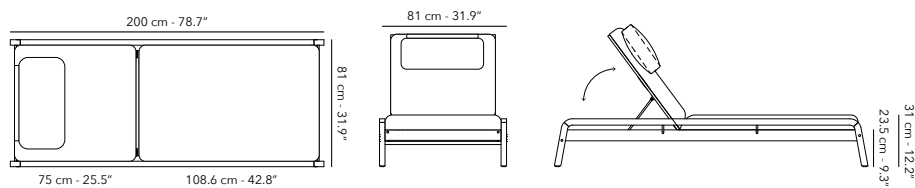

	<b>FUFLE-SL01</b> frame	 	<b>W62R30</b> teak & anthracite strap
	<b>CUFLESLO1</b> cushions		<b>C005</b> marble cat. C

 28 kg  
61.7 lbs

Other fabrics upon request.  
Find an overview on p. 225  
Protection cover available.



## DAYBED

	<b>FUFLEDB01</b> frame	 	<b>W62R30</b> teak & anthracite strap
	<b>CUFLEDB01</b> cushions		<b>C005</b> marble cat. C

 44 kg  
97 lbs

Other fabrics upon request.  
Find an overview on p. 225  
Protection cover available.

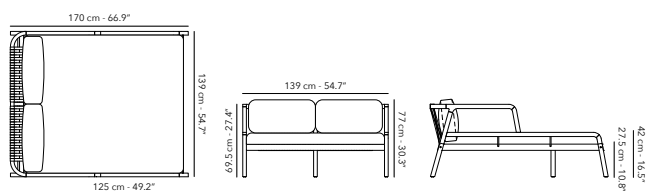

# VOLTE

## DINING TABLE 160 x 80 cm

	FUVOLDT41S frame		A01 white
	FUVOLTOP41 table top		A31 charcoal
		W62 teak	
		K01 white	
			K31 charcoal



Protection cover available.

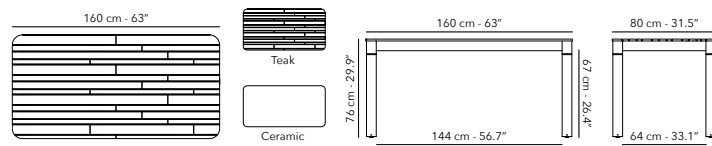

## DINING TABLE 240 x 100 cm

	FUVOLDT44S frame		A01 white
	FUVOLTOP44 table top		A31 charcoal
		W62 teak	
		K01 white	
		K31 charcoal	



Protection cover available.

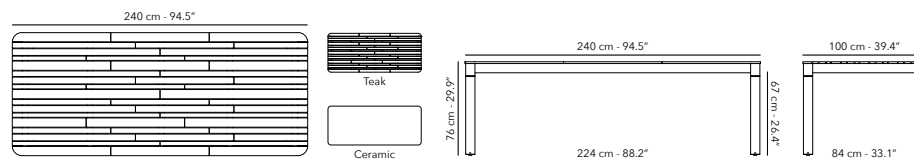

## DINING TABLE 300 x 100 cm

	FUVOLDT47S frame		A01 white
	FUVOLTOP47 table top		A31 charcoal
		W62 teak	
		K01 white	
		K31 charcoal	





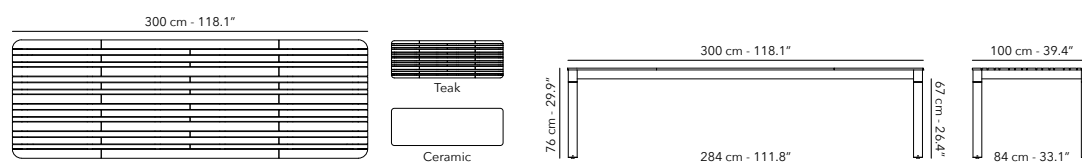



Protection cover available.



# VOLTE

## DINING TABLE ø 158 cm





	<b>FUVOLDT08S</b> frame	 <b>A01</b> white  <b>A31</b> charcoal
	<b>FUVOLTOP08</b> table top	 <b>W62</b> teak  <b>K01</b> white  <b>K31</b> charcoal

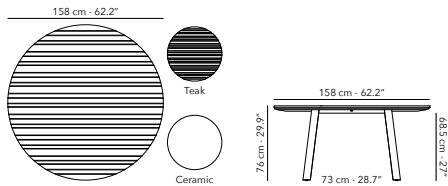

Protection cover available.



## BAR CHAIR





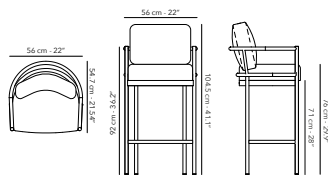

	<b>FUVOLBC02</b> frame	 <b>A01R02</b> white & silver  <b>A31R31</b> charcoal
	<b>CUVOLAC02</b> cushions	 <b>C009</b> desert cat. C  <b>C201</b> charcoal cat. A

8 kg  
17.6 lbs

Other fabrics upon request.  
Find an overview on p. 225  
Protection cover available.



## BAR TABLE 160 x 80 cm

	<b>FUVOLBT02S</b> frame	 <b>A01</b> white  <b>A31</b> charcoal
	<b>FUVOLTOP41</b> table top	 <b>W62</b> teak  <b>K01</b> white  <b>K31</b> charcoal





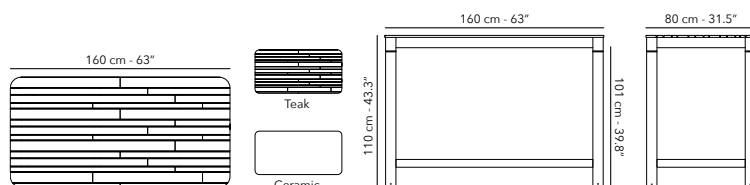

Protection cover available.



# VOLTE

## LOUNGE CHAIR 1S



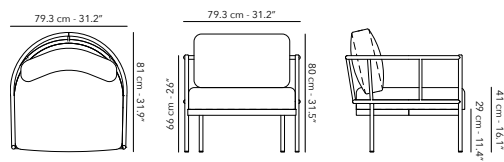

	FUVOL1S02 frame	 A01R02 white & silver  A31R31 charcoal
	CUVOL1S02 cushions	 C009 desert cat. C  C201 charcoal cat. A

11.5 kg  
25.3 lbs

Other fabrics upon request.  
Find an overview on p. 225  
Protection cover available.



## DINING TABLE 240 x 100 cm



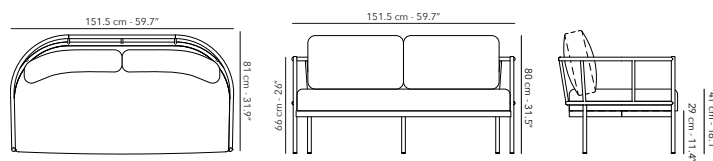

	FUVOL2S02 frame	 A01R02 white & silver  A31R31 charcoal
	CUVOL2S02 cushions	 C009 desert cat. C  C201 charcoal cat. A

30 kg  
66 lbs

Other fabrics upon request.  
Find an overview on p. 225  
Protection cover available.



## DINING TABLE 300 x 100 cm

	FUVOL3S02 frame	 A01R02 white & silver  A31R31 charcoal
	CUVOL3S02 cushions	 C009 desert cat. C  C201 charcoal cat. A

43.3 kg  
95.5 lbs

Other fabrics upon request.  
Find an overview on p. 225  
Protection cover available.

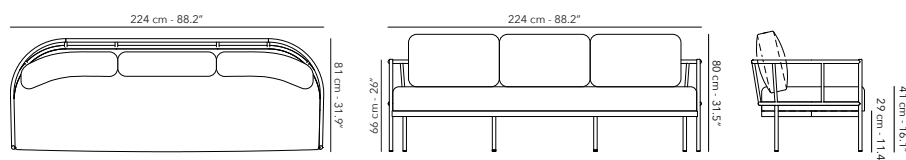

Aluminium powder coated frame with steel base.  
Chairs in full aluminium or with upholstered textile.

KUDOS  
UPDATED

**BISTRO CHAIR**



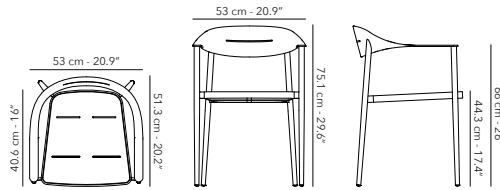

	<b>FUKUDBIA01</b> frame	 <b>A01 white</b>
		 <b>A03 linen NEW</b>
		 <b>A32 black</b>
		 <b>A69 lime</b>

 5.1 kg  
11.2 lbs

Sold per 3 pieces.  
3 pieces in 1 colour per box.





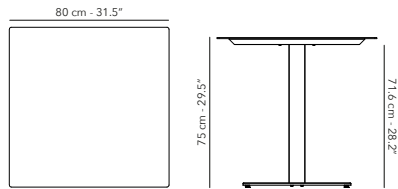

**BISTRO TABLE SQUARE** 80 x 80 cm

	<b>FUKUDBIT43</b> frame	 <b>A01 white</b>
		 <b>A03 linen NEW</b>
		 <b>A32 black</b>



 26 kg  
57.3 lbs



**BISTRO TABLE ROUND** ø 75 cm

	<b>FUKUDBIT03</b> frame	 <b>A01 white</b>
		 <b>A03 linen NEW</b>
		 <b>A32 black</b>

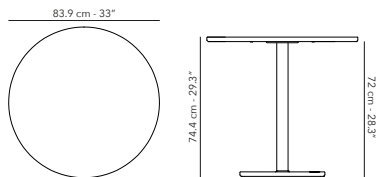



 17.2 kg  
40 lbs



# MANTRA



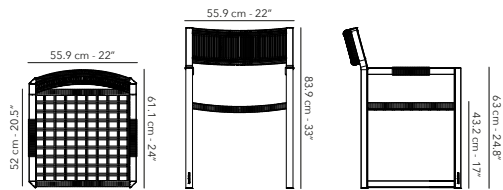

Aluminium powder coated frame with steel base.  
Chairs in full aluminium or with upholstered textile.

## BISTRO ARMCHAIR

	<b>FUMANBIA02</b> frame		<b>A01R02</b> white & silver	6 kg 13.2 lbs
			<b>A30R30</b> anthracite	





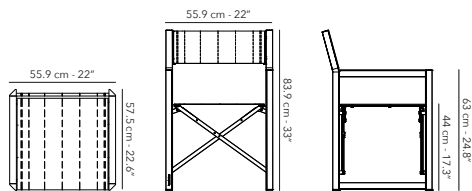

## DIRECTOR CHAIR

	<b>FUMANDC01</b> frame		<b>A01T02</b> white & silver	 6 kg 13.2 lbs
			<b>A30T30</b> anthracite	



# MANTRA

## BISTRO TABLE SQUARE 75 x 75 cm





	FUMANBIT22S frame		A01 white
			A30 anthracite
	FUMANBIT22T table top		A01 white
			A30 anthracite

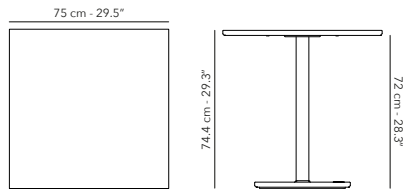

28.5 kg  
62.8 lbs



## BISTRO TABLE ROUND ø 80 cm



	FUMANBIT03S frame		A01 white
			A30 anthracite
	FUMANBIT03T table top		A01 white
			A30 anthracite

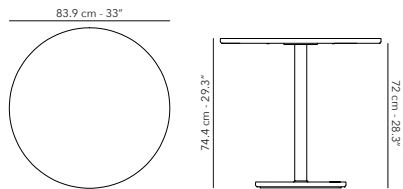

24.7 kg  
54.4 lbs



## SUNLOUNGER

	FUMANSL04 frame		A01T02 white & silver
			A30T30 anthracite



11 kg  
24.2 lbs

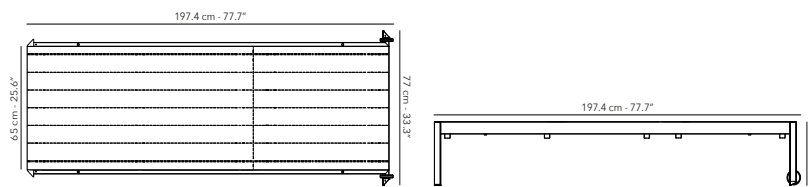

# BYBLOS



## BEACH CHAIR

	FUBYBSC01		W62T30 teak & anthracite
---	-----------	---	-----------------------------

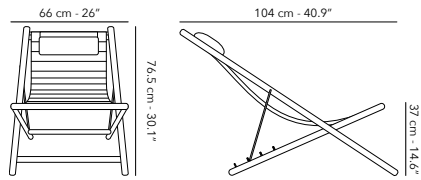
6 kg  
13.2 lbs



## STAND







	FUBYBSD01		W62 teak
--	-----------	--	----------

1.5 kg  
3.3 lbs



# NESTING TABLES

## NESTING SIDE TABLE ø 40 cm







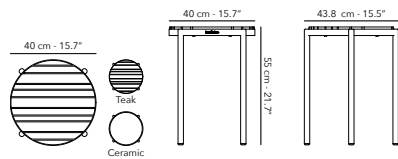

	<b>FUVOLST02S</b> frame	 <b>A01</b> white
		 <b>A31</b> charcoal
	<b>FUVOLTOP00</b> table top	 <b>W62</b> teak
		 <b>K01</b> white
		 <b>K14</b> taupegrey
		 <b>K31</b> charcoal



**K01 - K14 - K31**     **W62**  
 5.6 kg     3.5 kg  
 12.3 lbs     7.7 lbs



## NESTING SIDE TABLE ø 50 cm





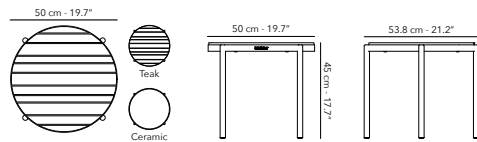

	<b>FUVOLST03S</b> frame	 <b>A01</b> white
		 <b>A14</b> lava
		 <b>A31</b> charcoal
	<b>FUVOLTOP01</b> table top	 <b>W62</b> teak
		 <b>K01</b> white
		 <b>K14</b> taupegrey
 <b>K31</b> charcoal		



**K01 - K14 - K31**     **W62**  
 7.6 kg     5 kg  
 16.8 lbs     11 lbs



## NESTING COFFEE TABLE ø 60 cm

	<b>FUVOLST06S</b> frame	 <b>A01</b> white
		 <b>A31</b> charcoal
		 <b>W62</b> teak
	<b>FUVOLTOP02</b> table top	 <b>K01</b> white
		 <b>K14</b> taupegrey
		 <b>K31</b> charcoal



**K01 - K14 - K31**     **W62**  
 10.5 kg     6 kg  
 23.1 lbs     13.2 lbs

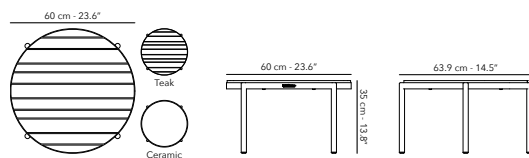

# NESTING TABLES

## NESTING COFFEE TABLE ø 75 cm

	FUVOLST04S frame	<input type="checkbox"/> A01 white <input checked="" type="checkbox"/> A14 lava <input checked="" type="checkbox"/> A31 charcoal
	FUVOLTOP03 table top	<input checked="" type="checkbox"/> W62 teak <input type="checkbox"/> K01 white <input type="checkbox"/> K14 taupegrey <input type="checkbox"/> K31 charcoal

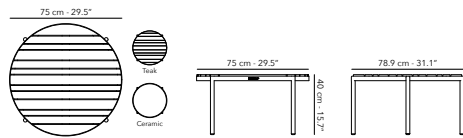

**K01 - K14 - K31**      **W62**  
 14.8 kg                      8 kg  
 32.6 lbs                    17.6 lbs



## NESTING COFFEE TABLE ø 90 cm

	FUVOLST05S frame	<input type="checkbox"/> A01 white <input checked="" type="checkbox"/> A14 lava <input checked="" type="checkbox"/> A31 charcoal
	FUVOLTOP04 table top	<input checked="" type="checkbox"/> W62 teak <input type="checkbox"/> K01 white <input type="checkbox"/> K14 taupegrey <input type="checkbox"/> K31 charcoal

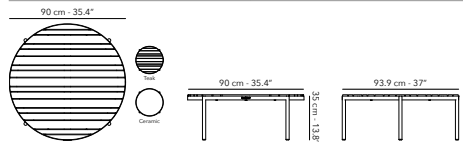
**K01 - K14 - K31**      **W62**  
 20.5 kg                      10 kg  
 45.2 lbs                    22 lbs



## DUNCAN

	DEDECDUN.01 teak block	<input checked="" type="checkbox"/> W62 teak	27.4 kg 60.4 lbs
---	---------------------------	--	---------------------

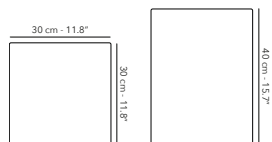

Filling of mixed fibre,  
polyester fibre & EPS beads.

# BOLSA

## NEW

### LOUNGE CHAIR 1S

	<b>FUBOL1S</b>	Cat. A
		Cat. B
		Cat. C
		Cat. D

14.5 kg  
31.9 lbs

Find an overview of  
the fabrics on p. 225

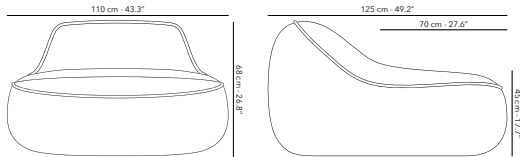

### CHAISE LONGUE

	<b>FUBOLCL</b>	Cat. A
		Cat. B
		Cat. C
		Cat. D

20.5 kg  
45.2 lbs

Find an overview of  
the fabrics on p. 225

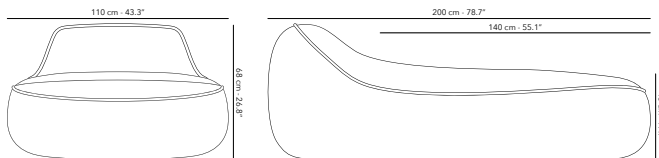





# POTTERY

## UPDATED

Each pot is handmade with natural materials, combined with FRP.  
A robust, yet lightweight pot, UV and frost resistant.







### TERRA DÔME SET

	<b>DEPOTTERD-SET1</b> ø 45 x 45 cm, 17.7 x 17.7" ø 61 x 61 cm, 24 x 24" ø 83 x 82 cm, 32.6 x 32.3"	 P03 sabbia
		 P11 macchiato
		 P32 nero













### TERRA CLASSIC

	<b>DEPOTTERC48.L</b> ø 48 x 57 cm, 19 x 22.5"	 P03 sabbia
		 P11 macchiato
		 P32 nero
	<b>DEPOTTERC60.M</b> ø 60 x 72 cm, 23.6 x 28.3"	 P03 sabbia
		 P11 macchiato
		 P32 nero
	<b>DEPOTTERC150.H</b> ø 150 x 180 cm, 59 x 71"	 P11 macchiato

### TERRA ALTO













	<b>DEPOTERR45.M</b> ø 45 x 112 cm, 18 x 44"	 P03 sabbia
		 P11 macchiato
		 P32 nero
	<b>DEPOTERR55.H</b> ø 55 x 137 cm, 22 x 54"	 P03 sabbia
		 P11 macchiato
		 P32 nero

### TERRA CERCHIO

	<b>DEPOTTERB-SET1:</b> DEPOTTERB91.H DEPOTTERB112.H	 P03 sabbia
		 P11 macchiato
		 P32 nero
	<b>DEPOTTERB91.H</b> ø 91 x 56 cm, 36 x 22"	 P03 sabbia
		 P11 macchiato
		 P32 nero
	<b>DEPOTTERB112.H</b> ø 112 x 67 cm, 44 x 26"	 P03 sabbia
		 P11 macchiato
		 P32 nero

# POTTERY



## TERRA BALLOON

	DEPOTTERB55.L ø 55 x 35 cm, 22 x 14"		P03 sabbia
			P11 macchiato
			P32 nero
	DEPOTTERB55.M ø 55 x 45 cm, 22 x 18"		P03 sabbia
			P11 macchiato
			P32 nero
	DEPOTTERB55.H ø 55 x 56 cm, 22 x 22"		P03 sabbia
			P11 macchiato
			P32 nero



## CUMINO ALBERO

	DEPOTCUM-SET1: DEPOTCUM52.L DEPOTCUM68.M DEPOTCUM88.H		P18 ruggine
	DEPOTCUM52.L ø 52 x 60 cm, 20 x 24"		P18 ruggine
	DEPOTCUM68.M ø 68 x 80 cm, 27 x 31"		P18 ruggine
	DEPOTCUM88.H ø 88 x 102 cm, 35 x 40"		P18 ruggine

## CUMINO FIORE



	DEPOTCUM-SET2 ø 55 x 46 cm, 21.6 x 18" ø 65 x 54 cm, 25.5 x 21.2" ø 80 x 66 cm, 31.5 x 26"		P18 ruggine
---	---	---	-------------

## CUMINO FUNGO

	DEPOTCUM114.L ø 114 x 54 cm, 56,7 x 21"		P01 panna
---	--	---	-----------

# POTTERY





## CUMINO CALICE

	<p><b>DEPOTCUMB120.H</b>          ø 120 x 130 cm, 47 x 51"</p>		<p><b>P01</b> panna</p>
---	--	---	-------------------------

## CURVO

	<p><b>DEPOTCUR-SET1:</b>          DEPOTCUR32.L          DEPOTCUR45.M          DEPOTCUR55.H</p>		<p><b>P30</b> caffè</p>
	<p><b>DEPOTCUR32.L</b>          ø 32 x 60 cm, 13 x 24"</p>		<p><b>P30</b> caffè</p>
	<p><b>DEPOTCUR45.M</b>          ø 45 x 80 cm, 18 x 31"</p>		<p><b>P30</b> caffè</p>
	<p><b>DEPOTCUR55.H</b>          ø 55 x 90 cm, 22 x 35"</p>		<p><b>P30</b> caffè</p>

## CARTELLO

	<p><b>DEPOTCAR75.L</b>          ø 75 x 35 cm, 30 x 14"</p>		<p><b>P31</b> marone</p>
	<p><b>DEPOTCAR75.H</b>          ø 75 x 68 cm, 30 x 27"</p>		<p><b>P31</b> marone</p>







# LIGHTING

## ARCQ

	<b>DELIGARC.S</b> Small ø 39 x 48.5 cm, 15 x 19"		F18 straw
	<b>DELIGARC.L</b> Large ø 48 x 60 cm, 19 x 24"		F18 straw





synthetic material with solar lamp

## ANTIBES

	<b>DECANANT.S</b> Small 21 x 21 x 50 cm 8 x 8 x 19.7"		W62 teak
	<b>DECANANT.M</b> Medium 30 x 30 x 60 cm 12 x 12 x 23.6"		W62 teak
	<b>DECANANT.L</b> Large 32 x 32 x 90 cm 13 x 13 x 35.4"		W62 teak
	<b>DEDECANT-TUB.01</b> Winetub ø 47 x 24 cm, 19 x 9"		W62 teak
	<b>DEDECANT-COOL.01</b> Winecooler ø 27 x 30 cm, 11 x 12"		W62 teak













teak with stainless steel parts

## INTEGRA

	<b>DECANINT.S</b> Small ø 30 x 35,5 cm, 12 x 14"		S99 black & gold
	<b>DECANINT.M</b> Medium ø 35,5 x 40,5 cm, 14 x 16"		S99 black & gold
	<b>DECANINT.L</b> Large ø 47 x 55,5 cm, 19 x 22"		S99 black & gold

steel lanterns for indoor use

## SOLORE Solar Hybrid module incl.

	<b>DELIGSOL.CS</b> Cube small 25 x 25 cm, 10 x 10"		F15 natural
	<b>DELIGSOL.CM</b> Cube medium 33,5 x 33,5 cm, 13 x 13"		F17 taupe
			F15 natural
	<b>DELIGSOL.CL</b> Cube large 43 x 43 cm, 17 x 17"		F17 taupe
			F15 natural
		<b>DELIGSOL.SS</b> Sphere small ø 30 x 24,5 cm, 12 x 10"	
<b>DELIGSOL.SM</b> Sphere medium ø 38,5 x 33,5 cm, 15 x 13"			F17 taupe
			F15 natural
<b>DELIGSOL.SL</b> Sphere large ø 47,5 x 43 cm, 19 x 17"			F17 taupe
			F15 natural



Solar-powered LED lamp for warm outdoor light. Rechargeable battery with solar energy or USB. Can be placed on the ground or hung up. Supplied with rope and USB cable. Control the light with the application "SLS Control". Available in the App Store and Google Play. The Solore Solar Module is included.

aluminium structure enclosed in HDPE fibre

# RUGS

## LONGI



<b>DERUGLON200X300</b> 200 x 300 cm, 79 x 118"		<b>D80</b> long hair ecru
<b>DERUGLON250X350</b> 250 x 350 cm, 98 x 138"		<b>D80</b> long hair ecru
		<b>D81</b> long hair grey
<b>DERUGLON300X400</b> 300 x 400 cm, 118 x 157"		<b>D80</b> long hair ecru
<b>DERUGLON300XR</b> ø 300 cm, 118"		<b>D80</b> long hair ecru
		<b>D81</b> long hair grey

hand woven polyolefin

## JUTE











<b>DERUGJUT200X300</b> 200 x 300 cm, 79 x 118"		<b>D82</b> jute
<b>DERUGJUT300X400</b> 300 x 400 cm, 118 x 157"		<b>D82</b> jute

hand braided polyolefin rope

## VASCO



<b>DERUGVAS170X240</b> 170 x 240 cm, 67 x 95"		<b>D84</b> charcoal
		<b>D85</b> aqua
<b>DERUGVAS200X300</b> 200 x 300 cm, 79 x 118"		<b>D84</b> charcoal
		<b>D85</b> aqua
<b>DERUGVAS250X350</b> 250 x 350 cm, 98 x 138"		<b>D84</b> charcoal
		<b>D85</b> aqua
<b>DERUGVAS250X250</b> 250 x 250 cm, 98 x 98"		<b>D84</b> charcoal
		<b>D85</b> aqua

100% hand woven, recycled PET



# RUGS

## HAMPTON

	<b>DERUGHAM200X300</b> 200 x 300 cm, 79 x 118"		D90 ivory (aqua - ivory)
			D91 taupe (taupe-taupe)
			D92 grey (ivory - taupe)
	<b>DERUGHAM250X350</b> 250 x 350 cm, 98 x 138"		D90 ivory (aqua - ivory)
			D91 taupe (taupe-taupe)
			D92 grey (ivory - taupe)
	<b>DERUGHAM300X400</b> 300 x 400 cm, 118 x 157"		D90 ivory (aqua - ivory)
			D91 taupe (taupe-taupe)

PET 80%, polyester 20%, hand woven

## WILSON

	<b>DERUGWIL200X300</b> 200 x 300 cm, 79 x 118"		D77 shell
			D78 oyster
			D79 greige
	<b>DERUGWIL250X350</b> 250 x 350 cm, 98 x 138"		D77 shell
			D78 oyster
			D79 greige
	<b>DERUGWIL280X390</b> 280 x 390 cm, 110 x 154"		D77 shell
			D78 oyster
			D79 greige

MADE IN BELGIUM

polyester and high-quality Decolan yarn



# POUFS

## JUTE

	<b>DEPOUJUT.RL</b> Large ø 75 x 35 cm, 30 x 14"		<b>D82</b> jute

hand braided polyolefin rope

## DONUT

	<b>DEPOUDONU.RS</b> Small ø 55 x 26 cm, 22 x 10"		<b>F14</b> bohemian
	<b>DEPOUDONU.RL</b> Large ø 110 x 36 cm, 43 x 14"		<b>F14</b> bohemian







hand woven wicker viro fiber

## LONGI

	<b>DEPOULON.RS</b> Small ø 50 x 40 cm, 19 x 16"		<b>D80</b> long hair ecru
			<b>D81</b> long hair grey
	<b>DEPOULON.RL</b> Large ø 100 x 40 cm, 39 x 16"		<b>D80</b> long hair ecru
			<b>D81</b> long hair grey

hand woven polyolefin

## HAMPTON

	<b>DEPOUHAM.SS</b> Small 50 x 50 x 40 cm 19 x 19 x 16"		<b>D93</b> oat
			<b>D95</b> mustard
			<b>D96</b> indigo
	<b>DEPOUHAM.SL</b> Large 100 x 100 x 40 cm 39 x 39 x 16"		<b>D93</b> oat
			<b>D94</b> metal
			<b>D95</b> mustard
		<b>D96</b> indigo	

PET 80%, polyester 20%, hand woven

# POUFS - DECO CUSHIONS

## BAY



### DEPOUBAY.RS

Small  
ø 50 x 40 cm, 19 x 16"

Cat. A / B / C / D

Free pick - other fabrics

### DEPOUBAY.RM

Medium  
ø 50 x 50 cm, 19 x 19"

Cat. A / B / C / D

Free pick - other fabrics

### DEPOUBAY.RL

Large  
ø 80 x 40 cm, 32 x 16"

Cat. A / B / C / D

Free pick - other fabrics

Find an overview of  
the fabrics on p. 225

100% solution dyed acrylic

## DECO CUSHION



### CUDECO40X40

40 x 40 cm

Cat. A / B / C / D

Free pick - other fabrics

### CUDECO50X50

50 x 50 cm

Cat. A / B / C / D

Free pick - other fabrics

Find an overview of  
the fabrics on p. 225

### FAST STOCK DECO CUSHION 40 X 40 CM



C015  
brulé cat. B



C111  
truffle cat. B



C306  
toast cat. B



C404  
diamond cat. C



C406  
pumpkin cat. A



C412  
royal cat. C



C415  
demin cat. A



C425  
leaf cat. A



C428  
azul cat. B



C432  
petrol cat. B

# FURNITURE OVERVIEW

## DINING CHAIRS



**Noa**  
Technical p. 162



**Noa**  
Technical p. 162



**Nero**  
Technical p. 167



**Tugu**  
Technical p. 170



**Tugu**  
Technical p. 170



**Legna**  
Technical p. 174



**Yuna**  
Technical p. 185



**Lewis / Lewis low**  
Technical p. 186



**Flexx**  
Technical p. 188



**Kudos**  
Technical p. 197



**Mantra**  
Technical p. 198



**Mantra director**  
Technical p. 198

# FURNITURE OVERVIEW

## BENCHES



**Tecca**  
Technical p. 184



**Nature**  
Technical p. 186

## BAR & COUNTER



**Flexx bar**  
Technical p. 188



**Flexx counter**  
Technical p. 188



**Volte bar**  
Technical p. 195



**Flexx bar**  
Technical p. 190



**Flexx counter**  
Technical p. 190



**Volte bar**  
Technical p. 195

# FURNITURE OVERVIEW

## DINING TABLES



**Noa**  
Technical p. 163



**Nero**  
Technical p. 167



**Legna**  
Technical p. 175



**Tecca**  
Technical p. 183



**Nature / Nature low**  
Technical p. 186



**Flexx**  
Technical p. 189



**Volte**  
Technical p. 194



**Volte**  
Technical p. 195

## BISTRO TABLES



**Flexx**  
Technical p. 189



**Bistro Kudos**  
Technical p. 197



**Bistro Kudos**  
Technical p. 197



**Bistro Mantra**  
Technical p. 199



**Bistro Mantra**  
Technical p. 199

# FURNITURE OVERVIEW

## LOUNGE CHAIRS



**Noa**  
Technical p. 164



**Nero**  
Technical p. 168



**Tugu**  
Technical p. 171



**Legna**  
Technical p. 176



**Scoop**  
Technical p. 178



**Mauroo**  
Technical p. 180



**Flex**  
Technical p. 191



**Volte**  
Technical p. 196



**Byblos**  
Technical p. 200



**Bolsa**  
Technical p. 203

# FURNITURE OVERVIEW

## SOFAS



**Noa**  
Technical p. 164



**Noa**  
Technical p. 164



**Nero**  
Technical p. 168



**Nero**  
Technical p. 168



**Tugu**  
Technical p. 171



**Tugu**  
Technical p. 171



**Tugu**  
Technical p. 172



**Legna**  
Technical p. 176



**Legna**  
Technical p. 176



**Scoop**  
Technical p. 178



**Scoop**  
Technical p. 178



**Mauroo**  
Technical p. 180



# FURNITURE OVERVIEW



**Mauro**  
Technical p. 180



**Mauro**  
Technical p. 181



**Flex**  
Technical p. 191



**Flex**  
Technical p. 191



**Volte**  
Technical p. 196



**Volte**  
Technical p. 196

## LOW TABLES



**Noa**  
Technical p. 165



**Noa**  
Technical p. 165



**Noa**  
Technical p. 165



**Noa**  
Technical p. 169



**Tugu**  
Technical p. 172



**Tugu**  
Technical p. 172



**Tugu**  
Technical p. 173



**Legna**  
Technical p. 177



**Legna**  
Technical p. 177



**Mauroo**  
Technical p. 181



**Flexx**  
Technical p. 192



**Flexx**  
Technical p. 192



**Flexx**  
Technical p. 192



**Nesting tables**  
Technical p. 201



**Nesting tables**  
Technical p. 201



**Duncan**  
Technical p. 202

## SUNLOUNGERS



**Noa**  
Technical p. 166



**Nero**  
Technical p. 169



**Tugu**  
Technical p. 173



**Legna**  
Technical p. 177



**Scoop**  
Technical p. 179



**Mauroo**  
Technical p. 181



**Tecca**  
Technical p. 185



**Flexx**  
Technical p. 193



**Bistro Mantra**  
Technical p. 199



**Bolsa**  
Technical p. 203

## DAYBEDS











**Flexx**  
Technical p. 193

# MAINTENANCE & PROTECTION

To enhance the durability and appearance, we recommend following our care instructions regularly. The umbrella should never be used in strong wind or rainy conditions. An open umbrella should never be left unattended. We always suggest storing your furniture and outdoor umbrella in a dry place when not in use or using a protective cover to avoid any blurring or damage.

COVER		
	UPJCP.1S-X77	JCP.1 Series
	UPJCP.202-X77	JCP. 202
	UPJCP.2S-X77	JCP.201 & JCP.203
	UPJCP.3S-X77	JCP.3 Series
	UPJCP.4S-X77	JCP.4 Series
	UPJCP.5S-X77	JCP.5 Series
	UPJCP.6S-X77	JCP.6 Series
	UPAZO-M-X75	Azore
	UPANT-M-X75	Antego
	UPKIN-L-X75	Kingston & Lima
	UPUMB-S-X75	Malibu
	UPAMA-M-X75	Amalfi
	UPCUB-M	Cuba & Moorea
	FP... X75	Furniture collection

CARE KIT		
	<b>SPCARE-TEXT-75CL</b> fabrics	2 sponges, 3 application cloths 1 textile protector 750ml 1 textile cleaner 750ml
	<b>SPCARE-STONE-50CL</b> natural stone	1 sponge, 1 applicaton cloth 1 natural stone protector 500ml 1 natural stone cleaner 500ml

CORRECTOR PEN 12 ML		
	<b>SPCOR-12ML</b>	 <b>A01</b> white
		 <b>A03</b> linen
		 <b>A11</b> taupe
		 <b>A14</b> lava
		 <b>A30</b> anthracite
		 <b>A31</b> charcoal
		 <b>A32</b> black

Quick-drying liquid paint with built-in brush for powder-coated surfaces. Ideal for retouching small surface traces (scratches, wear).

## ACCESSORIES



### LUNA LED LIGHT

UALUN-LED02

You create a warm glow by adding this outdoor umbrella light to the built-in holder on the frame. Luna LED light is wireless with 16 LEDs and gives a warm colour. Using the BT speaker, the module will play music for six to ten hours.

**Colour:** grey

**Light:** LED warm light

**Fits on:** Azore - Antego - Kingston - Lima - Amalfi - Malibu



### GUTTERS

Gutters offer an uninterrupted protection between several umbrellas. By connecting the parasols, large areas have a complete coverage against the sun or rainy weather. A gutter is always attached to the parasol with a slight slope in order to drain the water efficiently in the desired directions.

Our gutters are available in the same colour as the cloth of the parasol to match perfectly. Only applicable on the following parasols: JCP.201, JCP.202 and JCP.501.

# MATERIALS

## ALUMINIUM frame

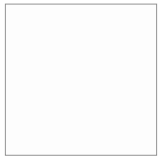

A01 white



A02 silver\*



A03 linen



A10 cappuccino



A12 alu teak



A14 lava



A30 anthracite



A31 charcoal



A32 black



A69 lime

Aluminium powder coated

\* A02 silver = aluminium anodised

## WOOD frame



W60 eucalyptus



W62 teak



W63 teak scratched



W64 sable teak



W68 black teak

W60 tropical hardwood with smooth finish

W64 teak with rough finish

W62 teak with matte finish

W64 & W68 teak with brushed finish and coloured coating

## STEEL Caractère collection umbrella base

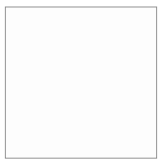

S01 white



S02 silver



S03 linen



S31 charcoal



S32 black

Hot galvanised powder coated steel plates, heavy and rust free.

# MATERIALS

## ROPE frame



R02 silver



R03 linen



R11 artichoke



R12 cream



R13 sand



R14 brown



R30 anthracite

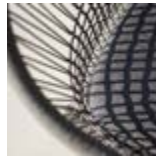

R31 charcoal



R32 black

UV-resistant polyolefin, woven by hand.

## WICKER frame



F16 cottage

Synthetic, high quality thermoplastic fiber. Resistant to great variations in temperature.

## CERAMIC frame



K01 white



K14 taupegrey

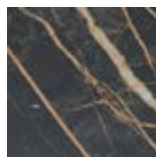

K31 charcoal

Hot galvanised powder coated steel plates, heavy and rust free.

# FABRICS

100% solution dyed acrylic or olefin  
 colour fastness: 7-8/8  
 resin based anti-fungal coating  
 water- and UV resistant  
 scratch- and dirt resistant

## CARACTÈRE canopy

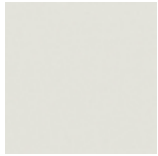

C003 pearl



C011 cotton



C100 ice

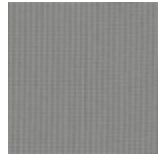

C107 mooncrest



C207 onyx



C210 pitch



C305 umber

## ATTITUDE canopy



C001 natural



C002 white



C010 latte

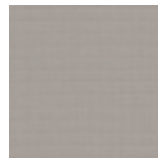

C101 cloud

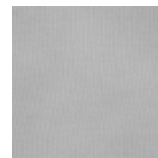

C105 light grey



C106 gris nature



C109 speckle

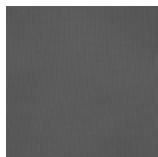

C200 dark grey



C204 night

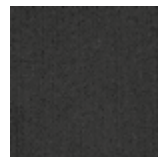

C208 black

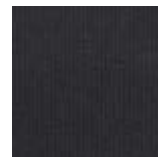

C209 coal

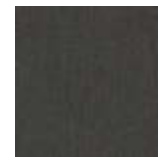

C211 steel



C212 gasoline

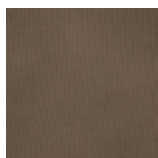

C301 taupe

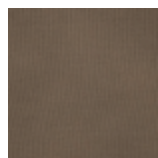

C302 mocca

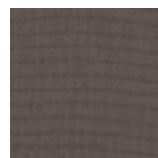

C304 walnut



C402 tangerine



C405 orange



C407 red



C409 brick



C417 jeans



C418 ocean



C421 kiwi



C424 spinach





**FAST STOCK**

Outdoor umbrella canopies and cushions available on stock.

# FABRICS

## FURNITURE cushions



**C005** marble  
cat. C



**C006** vanilla  
cat. B



**C007** beige  
cat. B



**C008** linen  
cat. A



**C009** desert  
cat. C



**C012** cream  
cat. B



**C015** brûlé  
cat. B



**C103** stone  
cat. A



**C104** quartz  
cat. C



**C111** truffle  
cat. B



**C201** charcoal  
cat. A



**C202** smoke grey  
cat. B

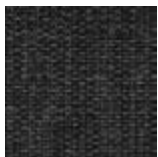

**C205** ebony  
cat. B



**C206** ash  
cat. A



**C306** toast  
cat. B

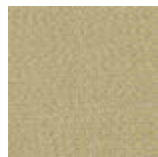

**C401** corn  
cat. C



**C404** diamond  
cat. C



**C406** pumpkin  
cat. A



**C408** flame  
cat. A



**C411** ruby  
cat. A



**C412** royal  
cat. C



**C415** denim  
cat. A



**C419** lime  
cat. C

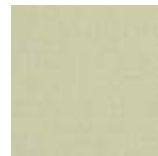

**C420** mint  
cat. A



**C422** sage  
cat. A



**C425** leaf  
cat. A



**C426** kaki  
cat. A



**C427** blush  
cat. D

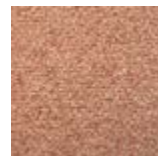

**C428** azul  
cat. B

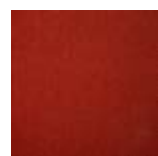

**C430** cotta  
cat. D



**C431** pacific  
cat. D

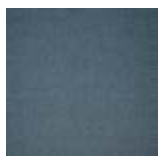

**C432** petrol  
cat. B



**T02** silver

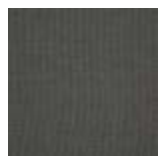

**T30** anthracite

Jardinico Parasols BV  
Evolis 101  
8530 Harelbeke  
Belgium  
+32 (0)56 89 04 10

[info@jardinico.com](mailto:info@jardinico.com)  
[www.jardinico.com](http://www.jardinico.com)



jardinico<sup>®</sup>



